

Active Noise Control for Periodic Disturbances

Marc Bodson, Jonathan S. Jensen and Scott C. Douglas *
Department of Electrical Engineering, University of Utah
Salt Lake City, UT 84112, U.S.A.

Abstract

This paper proposes an active noise control algorithm for periodic disturbances of unknown frequency. The algorithm is appropriate for the feedback case in which a single error microphone is used. A previously-proposed algorithm for the rejection of sinusoidal noise sources is extended for the cancellation of multiple harmonics. Unlike many other approaches, the estimates of the frequencies of the separate harmonics are tied together within the algorithm to account for the integer multiplicative relations between them. The dynamic behavior of the closed-loop system is analyzed using an approximation that is shown, in simulations, to provide an accurate representation of the system's behavior. Experimental results on an active noise control testbed demonstrate the success of the method in a practical environment.

1. Introduction

The problem of active noise control is considered, as shown in Fig. 1. A microphone is used to measure the instantaneous noise level at some location to be made quiet. The signal is sampled and then processed by a digital signal processing system, and an anti-noise field is generated through a loudspeaker. The objective is to eliminate or significantly reduce the noise level at the microphone through destructive interference.

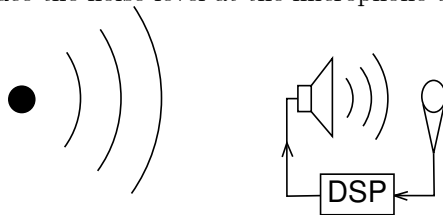

Figure 1: Active noise control (feedback scheme)

As shown in Fig. 1, the system configuration under consideration uses only one microphone. In other words, the situation is of a pure feedback nature, in contrast to the feedforward set-up that is often considered in such applications [1]. Moreover, the noise is assumed to be periodic in nature so that, from a control perspective, the problem is a classical rejection problem for periodic disturbances, except that the frequency of the disturbance is unknown and potentially time-varying.

*This material is based upon work supported by the U.S. Army Research Office under grant number DAAH04-96-1-0085. The content of the paper does not necessarily reflect the position or the policy of the federal government, and no official endorsement should be inferred.

A limited number of approaches exist to address the feedback control problem for periodic disturbances. They include adaptive algorithms employing the internal model principle [2, 3, 4] and extensions of adaptive algorithms for disturbances of known frequency [5, 6]. There has been recent interest in the control community in applying these algorithms to active noise and vibration control. [7] proposes new design techniques for systems with resonances, based on a result of linear time-invariant system equivalence. The algorithms are suited to periodic disturbances of unknown frequency, but a feedforward sensor is needed. [8] and [9] propose gradient-type algorithms for continuous-time and discrete-time systems, respectively. These algorithms have the advantage of adapting to uncertainty in both the disturbance and in the plant. Although the algorithms were tested with disturbances having a significant harmonic content, they do not specifically require this assumption. On the other hand, they are more complex than the algorithm discussed in this paper, and require other assumptions about the plant. [10] evaluates the potential of the internal model principle approach combined with adaptive pole placement techniques. The method is found to present significant difficulties, so that an alternative phase tuning approach is proposed. Simulations are presented, but no experiment is reported.

This paper extends the direct algorithm of [6] to the general case of periodic disturbances with multiple harmonics. A particular feature of the new algorithm is its use of the integer relationships between the harmonic components of the disturbance within the adaptive algorithm. Although the disturbance is assumed to be periodic, the periodic component of noise is typically the most annoying, and often the largest component of disturbances encountered in practical applications. The implicit assumption of this paper is that accounting for the periodic nature of this component of the disturbance may yield better results in terms of its rejection.

2. Adaptive Algorithm

2.1 Problem Statement

Assume that the transformation from the speaker to the microphone is a stable linear time-invariant system with transfer function $P(s)$ and that the effect of the noise source is additive. In the Laplace domain, the system can be modelled as

$$y(s) = P(s)(u(s) - d(s)), \quad (1)$$

where $y(s)$, $u(s)$ and $d(s)$ are the Laplace transforms of the microphone signal, of the speaker output, and of the equivalent noise signal at the speaker location, respectively. Alternatively, $u(t)$ may be viewed as the control input, $d(t)$ as the disturbance, and $y(t)$ as the plant output. The goal of the control system is

to generate $u(t)$ such that $y(t) \rightarrow 0$ as $t \rightarrow \infty$. The objective would be achieved if $u(t) = d(t)$, but the disturbance $d(t)$ is not known or measured in any way except through its effect at the output of the system. It is assumed to be a periodic signal, so that

$$\begin{aligned} d(t) &= \sum_{k=1}^n d_k \cos(\alpha_{k,d}(t)), \\ \dot{\alpha}_{k,d}(t) &= k\omega_1. \end{aligned} \quad (2)$$

The parameters ω_1 , d_k , and $\alpha_{k,d}(0)$ (for $k = 1, \dots, n$) are unknown. The order of the highest harmonic, n , is assumed to be finite and known. Certain harmonics may also be specified to be absent, *i.e.*, certain values of d_k may be known to be small *a priori*. For simplicity of presentation, we will consider the case where the fundamental and the third harmonic are present (only d_1 and d_3 are nonzero).

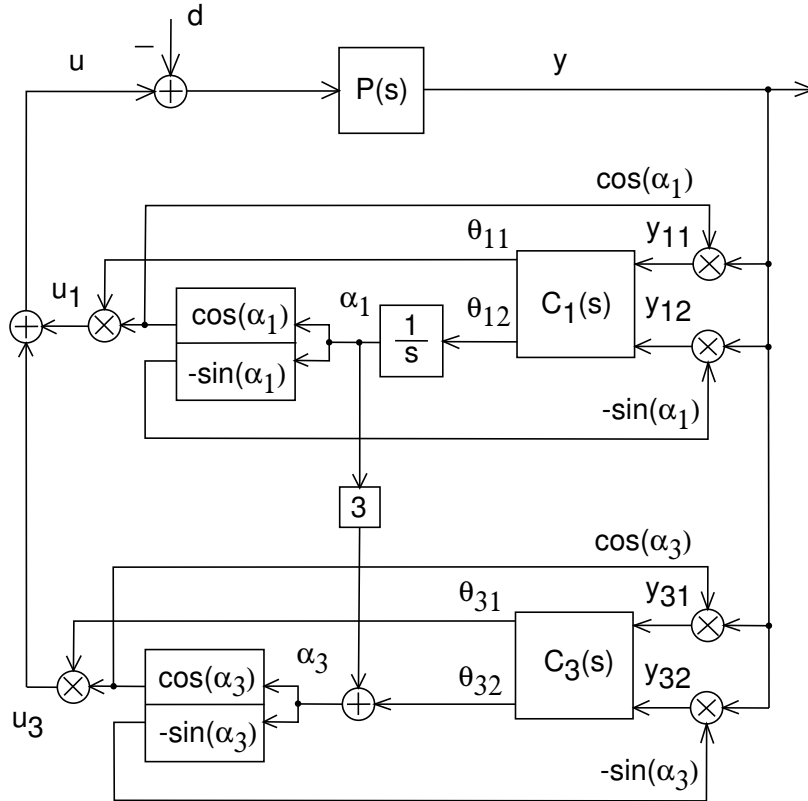

Figure 2: Adaptive Algorithm

2.2 Adaptive Algorithm

The structure of the proposed scheme is shown in Fig. 2. The signal u_1 nominally cancels the fundamental (at frequency ω_1), while the signal u_3 cancels the third harmonic. The parameters α_1 and α_3 are the estimates of the angles of the two components of the disturbance. The parameters θ_{11} and θ_{31} are the estimates of the

magnitudes of the two sinusoids, and θ_{12} is the estimate of the frequency of the fundamental. The value of θ_{12} is integrated to obtain the angle α_1 . For the third harmonic, θ_{32} is not the frequency but rather is the relative phase of the signal. The algorithm uses the assumption that the second sinusoid is a third harmonic of the fundamental by letting the angle α_3 be equal to the sum of three times the angle of the fundamental and of the relative phase θ_{32} .

The equations for the control algorithm are thus

$$\begin{aligned}
u &= \theta_{11} \cos(\alpha_1) + \theta_{31} \cos(\alpha_3) \\
\dot{\alpha}_1 &= \theta_{12}, \quad \alpha_3 = 3 \cdot \alpha_1 + \theta_{32} \\
y_{11} &= y \cos(\alpha_1), \quad y_{12} = -y \sin(\alpha_1) \\
y_{31} &= y \cos(\alpha_3), \quad y_{32} = -y \sin(\alpha_3).
\end{aligned} \tag{3}$$

The parameters have nominal values $\theta_{11}^* = d_1$, $\theta_{12}^* = \omega_1$, $\theta_{31}^* = d_3$, and $\theta_{32}^* = \alpha_{3,d}(0) - 3\alpha_{1,d}(0)$. For these values, and for $\alpha_1(t) - \omega_1 t = \alpha_{1,d}(0)$, the output converges to zero.

The transfer function matrix $C_1(s)$ relates the signals y_{11} and y_{12} to the parameters θ_{11} and θ_{12} , respectively. Similarly, the transfer function matrix $C_3(s)$ relates the signals y_{31} and y_{32} to the parameters θ_{31} and θ_{32} . The matrices $C_1(s)$ and $C_3(s)$ are the products of constant matrices with diagonal transfer function matrices. They are defined as follows. Consider the real and imaginary parts of the plant frequency response at the two frequencies of interest, given by

$$\begin{aligned}
P_{R,1} &= \text{Re}[P(j\omega_1)], \quad P_{R,3} = \text{Re}[P(3j\omega_1)], \\
P_{I,1} &= \text{Im}[P(j\omega_1)], \quad P_{I,3} = \text{Im}[P(3j\omega_1)],
\end{aligned} \tag{4}$$

and define the matrices

$$G_1 = \begin{pmatrix} P_{R,1} & -P_{I,1} \\ P_{I,1} & P_{R,1} \end{pmatrix}, \quad G_3 = \begin{pmatrix} P_{R,3} & -P_{I,3} \\ P_{I,3} & P_{R,3} \end{pmatrix}. \tag{5}$$

Variables x_{11} , x_{12} , x_{31} , and x_{32} are defined as

$$\begin{pmatrix} x_{11} \\ x_{12} \end{pmatrix} = G_1^{-1} \begin{pmatrix} y_{11} \\ y_{12} \end{pmatrix}, \quad \begin{pmatrix} x_{31} \\ x_{32} \end{pmatrix} = G_3^{-1} \begin{pmatrix} y_{31} \\ y_{32} \end{pmatrix}, \tag{6}$$

and the algorithm parameters are given by

$$\begin{aligned}
\dot{\theta}_{11} &= -2g_1 x_{11}, \quad \dot{\theta}_{12} = -2g_2 x_{12f}/d_{1e}, \\
\dot{\theta}_{31} &= -2g_3 x_{31}, \quad \dot{\theta}_{32} = -2g_3 x_{32}/d_{3e}.
\end{aligned} \tag{7}$$

The update laws are defined through integral relationships to guarantee zero steady-state errors. The control law for θ_{12} is slightly different from the others, with the signal x_{12} filtered so that

$$x_{12f}(s) = F(s)x_{12}(s), \quad F(s) = \frac{s+a}{s+b}. \quad (8)$$

The compensation filter is necessary to ensure the stability of the closed-loop system. The constants a , b , g_1 , g_2 , and g_3 will be adjusted to obtain satisfactory performance. The parameters d_{1e} and d_{3e} are estimates of d_1 and d_3 (see section 3.2).

To extend the algorithm for arbitrary harmonics, additional paths similar to that for the third harmonic in Fig. 2 may be added. The multiplying factor of 3, the matrix G_3 , and the estimate d_{3e} are the only elements that need to be changed. Note that, in the proposed implementation, frequency estimation is provided through the first harmonic. This choice is not essential, and frequency estimation based on another harmonic is possible.

3. Stability Analysis and Control Design

3.1 Stability Analysis

Our analysis of the system is based on a fundamental fact, whose proof is reminiscent of derivations found in the study of frequency-modulation communication systems [11] and of averaging methods applied to adaptive systems [12]. The following conditions are assumed:

- the values of θ_{11} , θ_{12} , θ_{31} , and θ_{32} vary sufficiently slowly that the response of the plant to the signal $u(t)$ may be approximated by the steady-state output of the plant for the two sinusoidal signals with frequencies θ_{12} and $3\theta_{12}$.
- the instantaneous frequency θ_{12} is close to ω_1 , so that $P(j\theta_{12})$ may be replaced by $P(j\omega_1)$ and $P(3j\theta_{12})$ may be replaced by $P(3j\omega_1)$.

Basic Fact: Considering low-frequency components only, the signals $x_{11}(t)$, $x_{12}(t)$, $x_{31}(t)$, and $x_{32}(t)$ are approximately given by

$$\begin{pmatrix} x_{i1}(t) \\ x_{i2}(t) \end{pmatrix} = \frac{1}{2} \begin{pmatrix} \theta_{i1}(t) - \theta_{i1}^* \cos(\alpha_i(t) - \alpha_{i,d}(t)) \\ \theta_{i1}^* \sin(\alpha_i(t) - \alpha_{i,d}(t)) \end{pmatrix} \quad (9)$$

for $i = \{1, 3\}$, with

$$\begin{aligned} \alpha_1(t) - \alpha_{1,d}(t) &= \int_0^t (\theta_{12}(\sigma) - \theta_{12}^*) d\sigma + \alpha_1(0) - \alpha_{1,d}(0), \\ \alpha_3(t) - \alpha_{3,d}(t) &= 3(\alpha_1(t) - \alpha_{1,d}(t)) + \theta_{32}(t) - \theta_{32}^*. \end{aligned} \quad (10)$$

The proof follows similar steps as in the proof in [6] and is omitted. The elimination of the high-frequency components within the system can be achieved through low-pass filtering of the signals. However, the signals are filtered within the compensators $C_1(s)$ and $C_3(s)$, and although the filtering is not ideal, simulations show that it is sufficient for the satisfactory operation of the system.

3.2 Compensator Design

Although the equations are nonlinear, a linear system is obtained if the parameters are close to their nominal values and the phase error $\delta\alpha_1(t) = \alpha_1(t) - \alpha_{1,d}(t)$ is small. The linearized system is

$$\begin{pmatrix} x_{11}(t) \\ x_{12}(t) \end{pmatrix} = \frac{1}{2} \begin{pmatrix} \theta_{11}(t) - \theta_{11}^* \\ \theta_{11}^* \delta\alpha_1(t) \end{pmatrix},$$

$$\begin{pmatrix} x_{31}(t) \\ x_{32}(t) \end{pmatrix} = \frac{1}{2} \begin{pmatrix} \theta_{31}(t) - \theta_{31}^* \\ \theta_{31}^* (3\delta\alpha_1(t) + \theta_{32}(t) - \theta_{32}^*) \end{pmatrix}. \quad (11)$$

The linearized dynamics from the parameters θ_{11} and θ_{12} to the variables x_{11} and x_{12} are decoupled from one another and are not dependent on the dynamics of the variables associated with the third harmonic. In closed-loop, the dynamics of θ_{11} are those of a first-order system with a pole at $s = -g_1$. For θ_{12} , the closed-loop poles are determined by the roots of $s^2(s + b) + g_2(s + a) = 0$, if $d_{1e} = d_1 = \theta_{11}^*$. Otherwise, g_2 is replaced by $g_2 d_1 / d_{1e}$. Stability is guaranteed if $g_2 > 0$ and $b > a > 0$. For the variables associated to the third harmonic, the closed-loop dynamics are those of a first-order system with a pole at $s = -g_3$. For θ_{32} , the pole is at $s = -g_3 d_3 / d_{3e}$ if d_{3e} is not equal to $d_3 = \theta_{31}^*$. The phase error $\delta\alpha_1(t)$ also appears as a disturbance on the equation for θ_{32} . The stability of the equation for θ_{12} ensures that this disturbance vanishes with time.

Because the magnitudes of the sinusoidal components d_1 and d_3 act as gains in the two transfer functions associated with phase locking, estimates of the parameters are used to ensure that the closed-loop poles are set at desirable values. However, the stability of the linear systems is not dependent upon the accuracy of these estimates. The algorithm also requires the knowledge of the matrices G_1 and G_3 , which depend on ω_1 . One may choose to set these matrices for a value of the frequency in the middle of the expected range of operation, or one may use the estimated frequency θ_{12} in real-time. Either way, knowledge of the frequency response of the plant in the frequency range of interest is required.

4. Simulation Results

The performance of the algorithm is examined via simulation. We consider a situation in which $P(s) = 100/(s + 100)$, $\omega_1 = 100$, $d_1 = 1$, and $d_3 = -1$. The parameters g_1 and g_3 are set to 10, leading to closed-loop poles for the first-order systems at -10 rad/s. The other parameters are set to $g_2 = 400$, $a = 5$, and

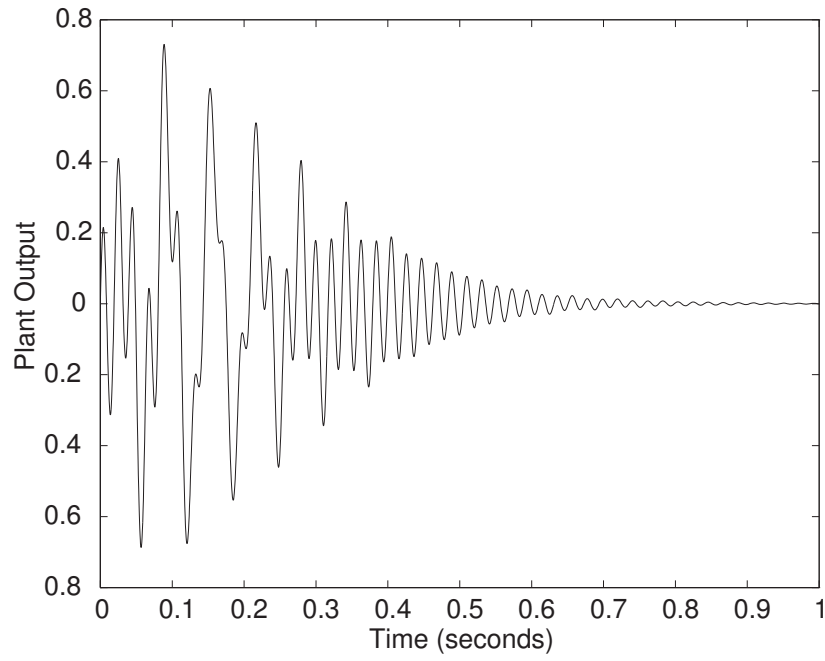

Figure 3: Plant output (y)

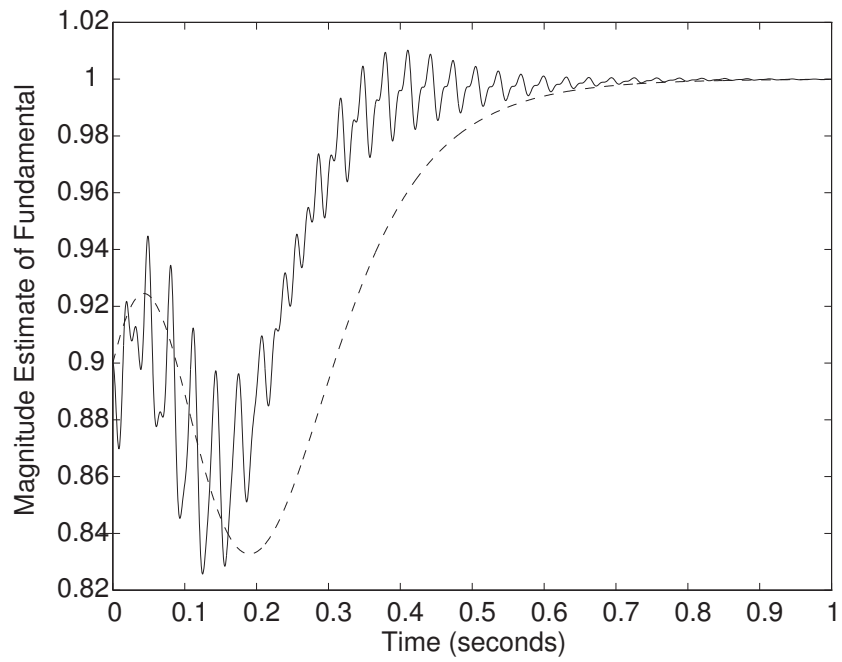

Figure 4: Magnitude of the fundamental (θ_{11})

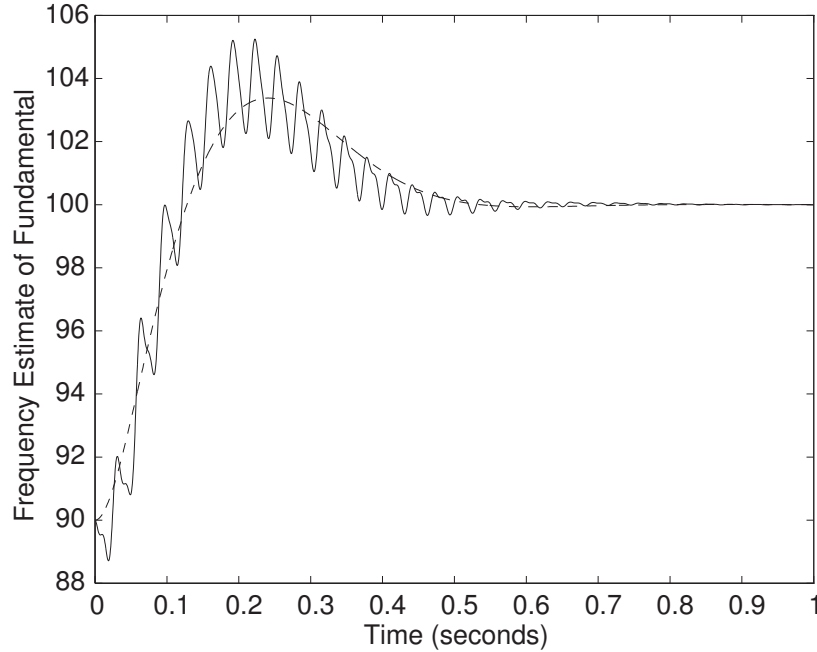

Figure 5: Frequency of the fundamental (θ_{12})

$b = 30$, leading to closed-loop poles for the frequency control loop located at -10 rad/s and $-10 \pm j10$ rad/s. The initial states of the parameters are zero, except for $\theta_{11}(0) = 0.9$, $\theta_{12}(0) = 90$ rad/s.

Fig. 3 shows the output of the plant, which is found to decrease to negligible values in less than a second. The transient behavior of the magnitude estimate θ_{11} is shown in Fig. 4, where the solid line is the parameter response, and the dashed line is the response predicted from a simulation of an approximate system. The approximate system is composed of the control law (7), (8), and the nonlinear approximation (9), (10). The frequency estimate θ_{12} is shown in Fig. 5. The matches between the actual and approximate behaviors is good, and the degree of match is similar to those for other adaptive systems [12].

The magnitude estimate for the third harmonic θ_{31} is shown in Fig. 6 and the phase estimate θ_{32} in Fig. 7. Note that the magnitude θ_{31}^* was set to -1 , and the estimate of the magnitude converged to 1, with the estimate of the phase converging to $-\pi$, or -180° . Again, the approximations are very good, and although the nonlinear effects are significant, the design based on the linear approximation is adequate to obtain convergence of the system.

5. Experimental Results

The scheme was implemented on an experimental active noise control system developed at the University of

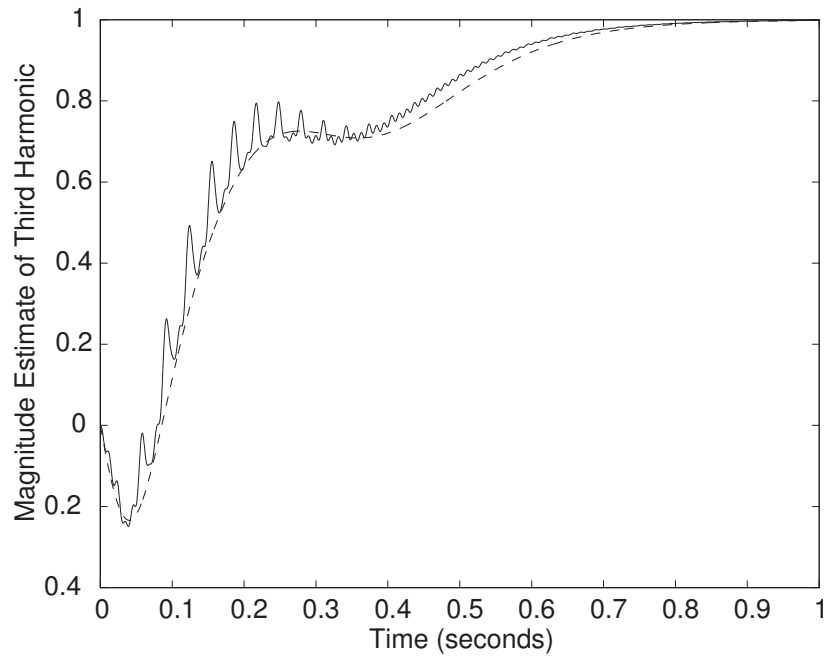

Figure 6: Magnitude of the third harmonic (θ_{31})

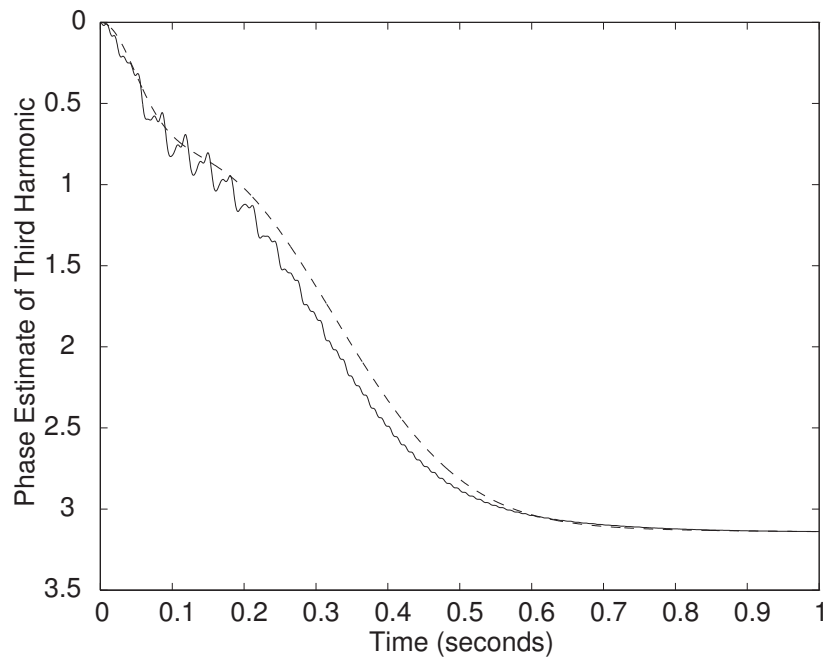

Figure 7: Phase of the third harmonic (θ_{32})

Utah. The algorithm was coded in assembly language on a Motorola DSP96002 32-bit floating-point digital signal processor, The sampling rate was set at 8 kHz. A single bookshelf speaker with a 4-inch low-frequency driver, located approximately 2 ft away from the error microphone, generated a periodic signal constituting the noise source. The microphone signal was passed through an anti-aliasing filter and sampled by a self-calibrating 16-bit analog-to-digital converter before being sent to the DSP system. The controller output signal was sent to a noise cancelling speaker placed approximately 1 ft away from the microphone. Only a single error sensing microphone signal was used.

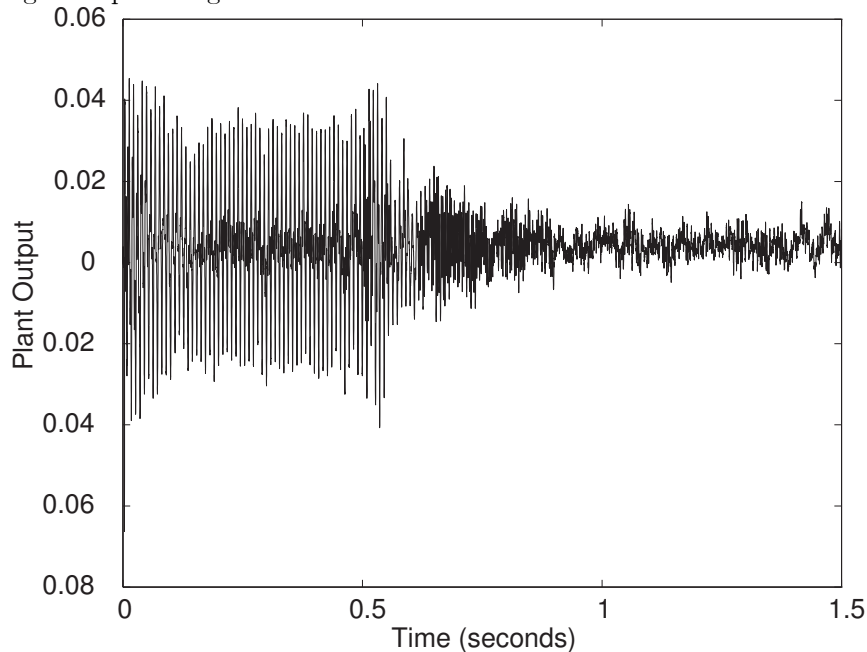

Figure 8: Microphone signal

The frequency response of the plant was determined during a rapid calibration phase in which pure sinusoidal tones were applied to the noise cancellation speaker, and the responses were measured by the microphone signal. The real and imaginary parts of the frequency response were obtained at 16 different frequencies, spaced logarithmically between 32.5 Hz and 1 kHz. In other experiments, the frequency response was calculated from a 50-tap finite impulse response model obtained with an adaptive identification algorithm and a white noise input. This identification procedure took longer. The matrices G_1 and G_3 were adjusted in real-time, based on the frequency estimate θ_{12} . Values from a look-up table were interpolated linearly as needed. Update of the matrices was performed every 8 samples. Because of the digital implementation, a discrete-time equivalent of the algorithm was implemented, with the z -domain poles placed in the vicinity of $z = 0.995$ for the parameters of the fundamental and $z = 0.99$ for the parameters of the third harmonic.

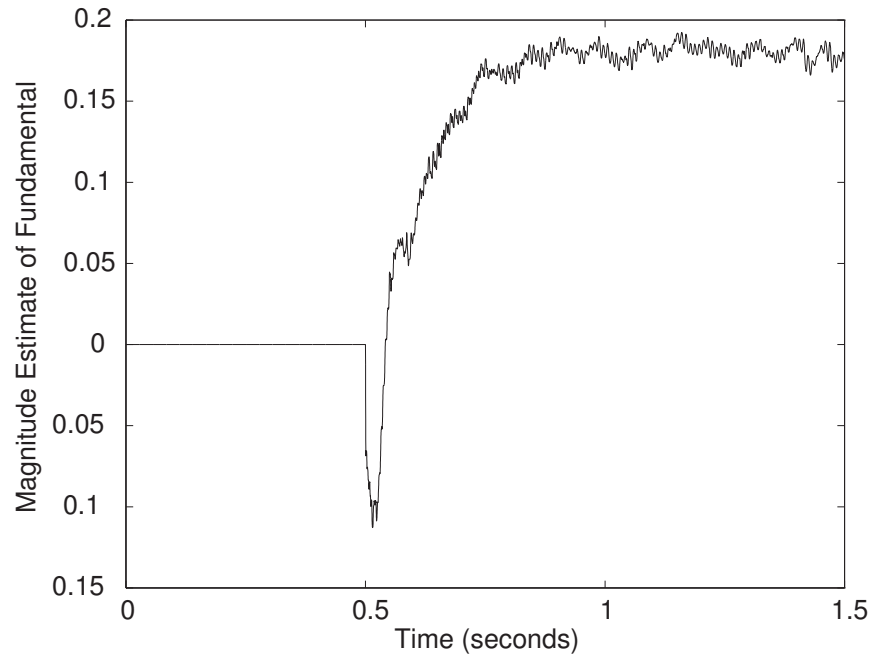

Figure 9: Magnitude of the fundamental (θ_{11})

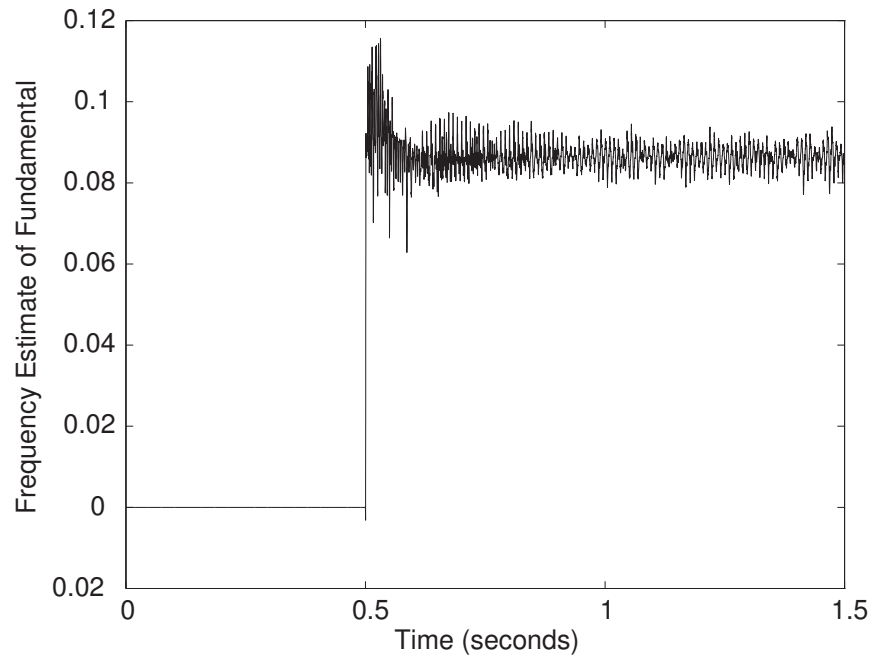

Figure 10: Frequency of the fundamental (θ_{12})

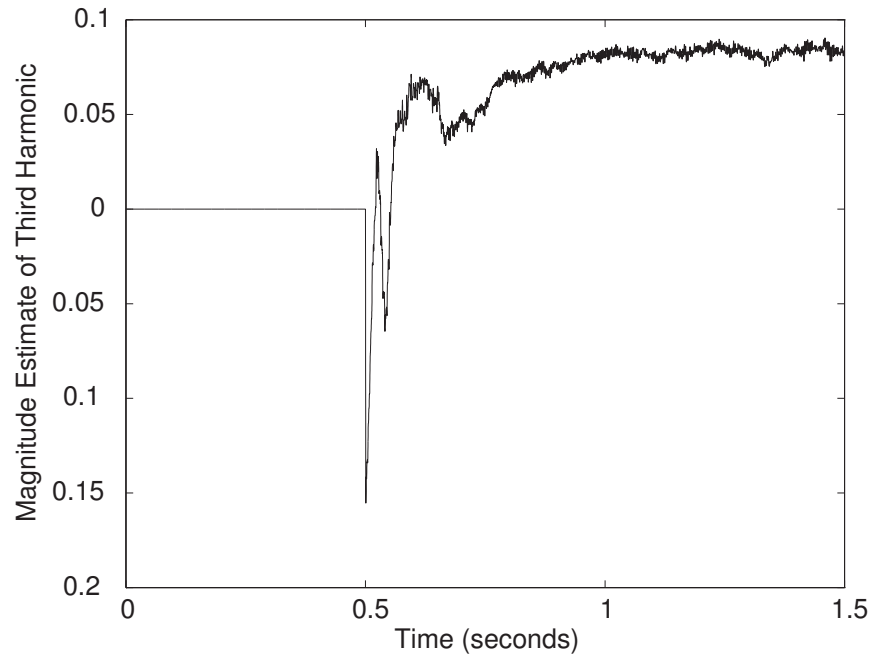

Figure 11: Magnitude of the third harmonic (θ_{31})

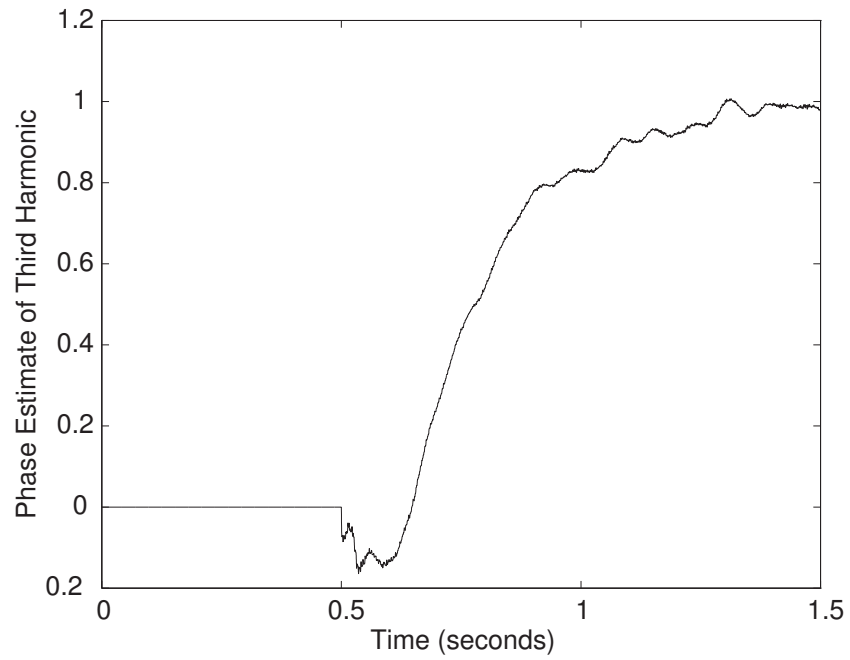

Figure 12: Phase of the third harmonic (θ_{32})

The results of one experiment are shown on Fig. 8, in which the signal at the error microphone is plotted as a function of time. The algorithm is not engaged until 0.5 sec. in the experiment, so that the amount of noise before compensation can be judged. The frequency of the fundamental is 110 Hz. The plot shows that the algorithm, once engaged, cancels the noise within a fraction of a second. The adaptive parameters for the fundamental are shown in Fig. 9 (magnitude estimate θ_{11}) and Fig. 10 (frequency estimate θ_{12}). The units of the frequency estimate are given in radians/sample; *i.e.*, $2\pi \cdot 110/8000 = 0.086$. The initial frequency estimate corresponded to 115 Hz. Other parameters were initially set to zero. Shown in Fig. 11 and 12 are the parameters related to the third harmonic (magnitude estimate θ_{31} and phase estimate θ_{32} (in rad)). It was found that the frequency of the disturbance could vary over a wide range, once the algorithm had locked onto the disturbance frequency. Techniques from phase-locked loops could be used to expand the lock-in range [11] but were not implemented. Other experiments employing several harmonics as well as frequency estimation using high-order harmonics provided results comparable to those shown.

6. Conclusions

An adaptive algorithm is proposed for the rejection of periodic disturbances of unknown frequency. For simplicity, the algorithm is described for a noise consisting of a fundamental component and a third harmonic, although the method is easily extended to noises with an arbitrary number of harmonics. As in other solutions to this control problem, the closed-loop system is a complex nonlinear time-varying system. However, we showed that an approximate nonlinear time-invariant system provided a very accurate representation of the dynamic behavior of the system. A further approximation of the system through linearization was useful for the selection of the design parameters. The algorithm was tested experimentally on an active noise control system at the University of Utah to demonstrate the success of the method in a practical environment.

A limitation of the algorithm proposed in the paper is the restriction to single-input single-output systems. The algorithm is appropriate for earphone type of applications, but not for the cancellation of noise in open-space. The extension to multi-channel systems is possible, but has not been completed so far. Alternatively, the indirect approach of [6] has been extended to multi-channel systems with sinusoidal disturbances and tested successfully, with the results reported in [13].

7. References

References

- [1] S. Kuo and D. Morgan, *Active Noise Control Systems: Algorithms and DSP Implementations*, New York, Wiley, 1996.
- [2] K. Narendra and A. Annaswamy, *Stable Adaptive Systems*, Prentice-Hall, Englewood Cliffs, NJ, 1989.
- [3] G. Feng and M. Palaniswamy, "A Stable Adaptive Implementation of the Internal Model Principle," *IEEE Trans. on Automatic Control*, vol. 37, no. 8, pp. 1220-1225, 1992.
- [4] B. Francis and M. Vidyasagar, "Linear Multivariable Regulation with Adaptation: Tracking Signals Generated by Models with Unknown Parameters," *Proc. of the IEEE Conference on Decision and Control*, 1978.
- [5] G. Chaplin and R. Smith, "Method of and Apparatus for Cancelling Vibrations from a Source of Repetitive Vibrations," U.S. Patent 4,566,118, Jan. 21, 1986.
- [6] M. Bodson and S.C. Douglas, "Adaptive Algorithms for the Rejection of Periodic Disturbances with Unknown Frequency," *Automatica*, vol. 33, no. 12, pp. 2213-2221, 1997.
- [7] D. Bayard, "A Modified Augmented Error Algorithm for Adaptive Noise Cancellation in the Presence of Plant Disturbances," *Proc. of the American Control Conference*, Philadelphia, PA, 1998.
- [8] F. Ben-Amara, "Robust Adaptive Sinusoidal Disturbance Rejection in Linear Continuous-Time Systems," *Proc. of the IEEE Conference on Decision and Control*, San Diego, CA, pp. 1878-1883, 1997.
- [9] R. Venugopal & D. Bernstein, "Adaptive Disturbance Rejection Using ARMARKOV/Toeplitz Models," *Proc. of the American Control Conference*, Albuquerque, NM, 1997.
- [10] Y. Zhang, P. Mehta, R. Bitmead, & C. Johnson, "Direct Adaptive Control for Tonal Disturbance Rejection," *Proc. of the American Control Conference*, Philadelphia, PA, pp. 1480-1482, 1998.
- [11] J.R. Smith, *Modern Communications Circuits*, Mc Graw-Hill, New York, NY, 1997.
- [12] S. Sastry and M. Bodson, *Adaptive Control: Stability, Convergence, and Robustness*, Prentice-Hall, Englewood Cliffs, NJ, 1989.
- [13] B. Wu & M. Bodson, "Multi-Channel Active Noise Control for Periodic Disturbances," *Proc. of the IEEE Conference on Decision and Control*, Phoenix, AZ, 1999.