

Frequency Response

In the Capacitors lab you made a "frequency dependent voltage divider" whose output was not the same for all frequencies of input. You made a graph of the output voltage as a function of the input frequency. That was a *frequency response* graph of the circuit. You made similar graphs in the Resonance lab. These graphs help show the relationship of the output to the input as a function of frequency. This relationship is known as the frequency response of the circuit. You may have heard the term used before in connection with speakers or microphones. All electrical and mechanical systems have frequency response characteristics. Sometimes the frequency response can be quite dramatic, like the Tacoma Narrows bridge.

Filter Circuits

A circuit which *passes* some frequencies and *filters out* other frequencies is called (surprise, surprise) a "filter" and this selection and rejection of frequencies is called "filtering". The tone or equalization controls on your stereo are frequency filters. So are the tuners in TVs and radios.

If a filter passes high frequencies and rejects low frequencies, then it is a high-pass filter. Conversely, if it passes low frequencies and rejects high ones, it is a low-pass filter. A filter that passes a range or band of frequencies and rejects frequencies lower or higher than that band, is a band-pass filter. The opposite of this is a band-rejection filter, or if the band is narrow, a notch filter or trap.

Look at the circuit at right. At low frequencies the impedance of the inductor is low and the output voltage is essentially shorted to ground. At high frequencies the impedance of the inductor is high and the output is about the same as the input. This is a high-pass filter. We can determine the relationship between the input and output:

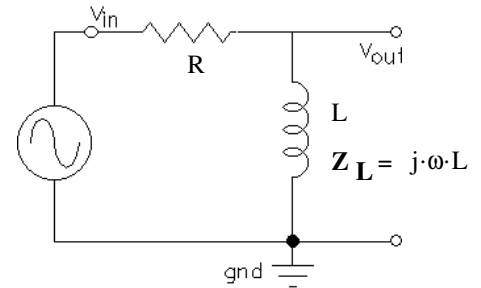

$$V_{\text{out}} = \frac{j \cdot \omega \cdot L}{R + j \cdot \omega \cdot L} \cdot V_{\text{in}} \quad \text{OR:} \quad \frac{V_{\text{out}}}{V_{\text{in}}} = \frac{j \cdot \omega \cdot L}{R + j \cdot \omega \cdot L} = H(\omega)$$

= The "Transfer Function"

A *transfer function* is a general term used for any linear system that has an input and an output. It is simply the ratio of output to input. The idea is that if you multiply the input by the transfer function, you get the output.

$$H(\omega) = \frac{j \cdot \omega \cdot L}{R + j \cdot \omega \cdot L}$$

At low frequencies: $R \gg j \cdot \omega L$ and $H(\omega) \simeq \frac{j \cdot \omega \cdot L}{R}$ output is proportional to frequency

At high frequencies: $R \ll j \cdot \omega L$ and $H(\omega) \simeq \frac{j \cdot \omega \cdot L}{j \cdot \omega \cdot L} = 1$ output is about the same as the input.

Naturally, a plot of the transfer function versus frequency would be a handy thing. You've already made similar plots in the lab. It turns out that these plots are best done on a log-log scale. Unfortunately, they are actually plotted on a semilog scale using a special unit in the vertical axis called the *decibel* (dB) and the log is built into this dB unit. The dB unit doesn't really simplify things, but it is widely used and you'll need to know about it, so here goes.

Decibels

Your ears respond to sound logarithmically, both in frequency and in intensity.

Musical octaves are in ratios of two. "A" in the middle octave is 220 Hz, in the next, 440 Hz, then 880 Hz, etc...

It takes about ten times as much power for you to sense one sound as twice as loud as another.

10x power \simeq 2x loudness

A bel is such a

10x ratio of power.

$$\text{Power ratio expressed in bels} = \log\left(\frac{P_2}{P_1}\right) \text{ bels}$$

The bel is named for Alexander Graham Bell, who did original research in hearing.

It is a logarithmic expression of a unitless ratio (like the magnitude of $H(\omega)$ or gain of an amplifier).

The bel unit is never actually used, instead we use the decibel (dB, 1/10th of a bel).

$$\text{Power ratio expressed in dB} = 10 \cdot \log\left(\frac{P_2}{P_1}\right) \text{ dB}$$

ECE 2210 Bode plot Notes p2

dB are also used to express voltage and current ratios, which is related to power when squared. $P = \frac{V^2}{R} = I^2 \cdot R$

$$\text{Voltage ratio expressed in dB} = 10 \cdot \log\left(\frac{V_2^2}{V_1^2}\right) \text{ dB} = 20 \cdot \log\left(\frac{V_2}{V_1}\right) \text{ dB}$$

These are the most common formulas used for dB

$$\text{Current ratio expressed in dB} = 20 \cdot \log\left(\frac{I_2}{I_1}\right) \text{ dB}$$

Some common ratios expressed as dB

$20 \cdot \log\left(\frac{1}{\sqrt{2}}\right) = -3.01 \cdot \text{dB}$	$10^{-\frac{3}{20}} = 0.708$	$20 \cdot \log(\sqrt{2}) = 3.01 \cdot \text{dB}$	$10^{\frac{3 \cdot \text{dB}}{20}} = 1.413$
$20 \cdot \log\left(\frac{1}{2}\right) = -6.021 \cdot \text{dB}$	$10^{-\frac{6}{20}} = 0.501$	$20 \cdot \log(2) = 6.021 \cdot \text{dB}$	$10^{\frac{6 \cdot \text{dB}}{20}} = 1.995$
$20 \cdot \log\left(\frac{1}{10}\right) = -20 \cdot \text{dB}$	$10^{-\frac{20}{20}} = 0.1$	$20 \cdot \log(10) = 20 \cdot \text{dB}$	$10^{\frac{20 \cdot \text{dB}}{20}} = 10$
$20 \cdot \log\left(\frac{1}{100}\right) = -40 \cdot \text{dB}$	$10^{-\frac{40}{20}} = 0.01$	$20 \cdot \log(100) = 40 \cdot \text{dB}$	$10^{\frac{40 \cdot \text{dB}}{20}} = 100$

Other dB-based units

You may have encountered dB as an absolute measure of sound intensity (Sound Pressure Level or SPL). In that case the RMS sound pressure is compared as a ratio to a reference of 2×10^{-5} Pascals.

dBm is another absolute power scale expressed in dB. Powers are referenced to 1mW.

Volume Units (VU) are dBm with the added spec that the load resistor is 600Ω .

Bode Plots

Named after Hendrik W. Bode (bo-dee), bode plots are just frequency response curves made on semilog paper where the horizontal axis is frequency on a \log_{10} scale and the vertical axis is either dB or phase angle. The plots are nothing special, but the method that Bode came up with to make them quickly and easily *is* special. We aren't going to bother with the phase-angle plots in this class, but since the bode method of making frequency plots is so simple it's worth our time to see how it's done.

Basically, these are the steps:

1. Find the transfer function.
2. Analyze the transfer function to find "corner frequencies" and use these to divide the frequency into ranges.
3. Simplify and approximate the magnitude of the transfer function in each of these ranges.
4. Draw a "straight-line approximation" of the frequency response curve.
5. Use a few memorized facts to draw the actual frequency response curve.

The best way to learn the method is by examples.

Ex. 1

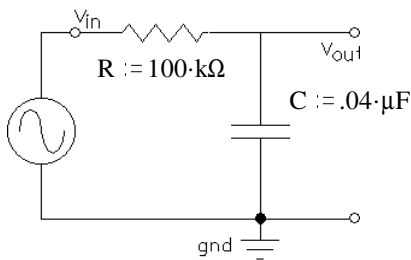

$$\frac{V_{\text{out}}}{V_{\text{in}}} = \frac{1}{j \cdot \omega \cdot C + R} = \frac{1}{1 + R \cdot (j \cdot \omega \cdot C)} = \mathbf{H(\omega)} = \text{The "Transfer Function"}$$

corner frequency is where real = imaginary (in denominator in this case)

$$1 = \omega_c \cdot R \cdot C \quad \omega_c := \frac{1}{R \cdot C} \quad \omega_c = 250 \cdot \frac{\text{rad}}{\text{sec}} \quad \text{So... } \mathbf{H(\omega)} := \frac{1}{1 + j \cdot \frac{\omega}{250 \cdot \frac{\text{rad}}{\text{sec}}}}$$

ω_c is also called a "pole" frequency

The transfer function is said to have one "pole" at ω_c

ECE 2210 Bode plot Notes p3

To make a straight-line approximation of the magnitude of $\mathbf{H}(\omega)$ we'll approximate $|\mathbf{H}(\omega)|$ in two regions, one below the corner frequency, and one above the corner frequency. Keep only the real or only the imaginary part of the denominator, depending on which is greater.

below the corner frequency: $\omega < \omega_c$ $\mathbf{H}(\omega) \simeq \frac{1}{1}$ $|\mathbf{H}(\omega)| \simeq 1$ $20 \cdot \log(1) = 0 \text{ dB}$

above the corner frequency: $\omega > \omega_c$ $\mathbf{H}(\omega) \simeq \frac{1}{j \cdot \frac{\omega}{250 \frac{\text{rad}}{\text{sec}}}}$ $|\mathbf{H}(\omega)| \simeq \frac{1}{\omega} \cdot \left(250 \cdot \frac{\text{rad}}{\text{sec}} \right)$ inversely proportional to ω .

Inverse proportionality is a straight 1 to 1 down slope on a log-log plot, with dB it's only slightly different. Since 10x corresponds to 20 dB, the line goes down 20 dB for every 10x increase in frequency (called a decade).

That's all you need to make the straight-line approximation shown in the plot below. (If you know the slope)

Try some values above the corner frequency:

$$20 \cdot \log \left[\frac{1}{10 \cdot \omega_c} \cdot \left(250 \cdot \frac{\text{rad}}{\text{sec}} \right) \right] = -20 \text{ dB} \qquad 20 \cdot \log \left[\frac{1}{100 \cdot \omega_c} \cdot \left(250 \cdot \frac{\text{rad}}{\text{sec}} \right) \right] = -40 \text{ dB}$$

The slope above the corner frequency is -20 dB per "decade".

A decade is a 10x increase in frequency.

This slope is also -6dB per "octave" (a 2x increase in frequency).

Let's find the actual magnitude of $\mathbf{H}(\omega)$ right at the corner frequency ($\mathbf{H}(\omega_c)$):

$$\omega = \omega_c \qquad \mathbf{H}(\omega) = \frac{1}{1 + j \cdot \frac{\omega_c}{250 \frac{\text{rad}}{\text{sec}}}} = \frac{1}{1 + j \cdot 1}$$

$$|\mathbf{H}(\omega)| = \frac{1}{\sqrt{2}} \qquad 20 \cdot \log \left(\frac{1}{\sqrt{2}} \right) = -3.01 \text{ dB}$$

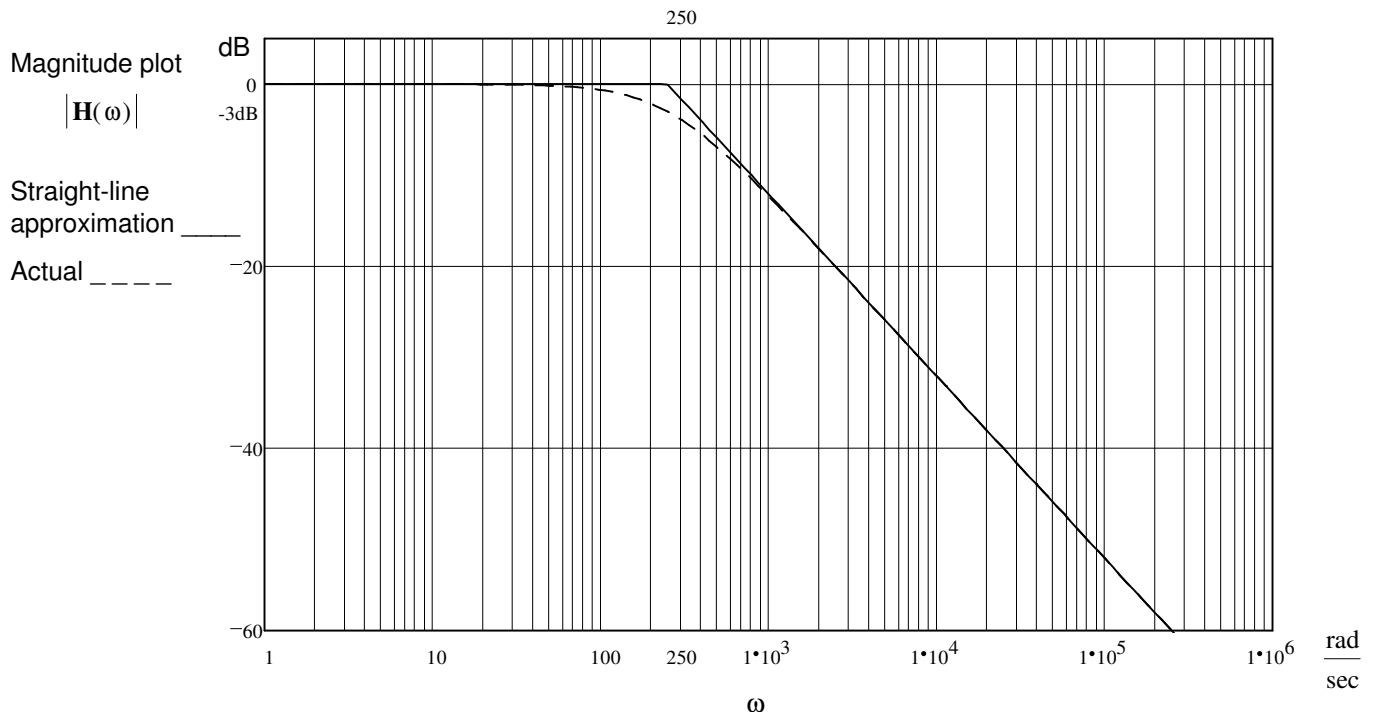

ECE 2210 Bode plot Notes p4

Ex. 2

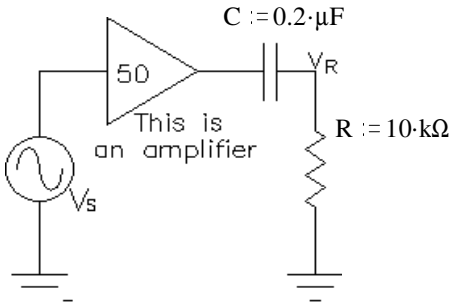

$$\frac{V_R}{V_S} = 50 \cdot \frac{R}{\frac{1}{j \cdot \omega \cdot C} + R} = \frac{50 \cdot (R \cdot (j \cdot \omega \cdot C))}{1 + R \cdot (j \cdot \omega \cdot C)} = H(\omega)$$

Transfer function has one pole at ω_c

corner frequency is where real = imaginary

$$1 = \omega_c \cdot R \cdot C \quad \omega_c := \frac{1}{R \cdot C} \quad \omega_c = 500 \cdot \frac{\text{rad}}{\text{sec}}$$

$$\text{So... } H(\omega) := \frac{50 \cdot j \cdot \frac{\omega}{500 \cdot \frac{\text{rad}}{\text{sec}}}}{1 + j \cdot \frac{\omega}{500 \cdot \frac{\text{rad}}{\text{sec}}}} = \frac{50 \cdot j \cdot \omega}{500 \cdot \frac{\text{rad}}{\text{sec}} + j \cdot \omega} \quad \text{OR: } H(\omega) := \frac{50 \cdot j \cdot \frac{\omega}{\omega_c}}{1 + j \cdot \frac{\omega}{\omega_c}}$$

$$\omega < \omega_c \quad H(\omega) \simeq \frac{50 \cdot j \cdot \frac{\omega}{500 \cdot \frac{\text{rad}}{\text{sec}}}}{1} = \frac{0.1 \cdot \frac{\text{sec}}{\text{rad}} \cdot j \cdot \omega}{1} \quad |H(\omega)| \simeq 0.1 \cdot \frac{\text{sec}}{\text{rad}} \cdot \omega$$

Proportional to ω . That's all we need to know here. This proportionality to ω will result in a +20 dB per decade slope for all frequencies below the corner frequency

$$\omega > \omega_c \quad H(\omega) \simeq \frac{50 \cdot j \cdot \frac{\omega}{500 \cdot \frac{\text{rad}}{\text{sec}}}}{j \cdot \frac{\omega}{500 \cdot \frac{\text{rad}}{\text{sec}}}} \quad |H(\omega)| \simeq 50 \quad 20 \cdot \log(50) = 33.98 \cdot \text{dB} \quad \text{The "pass band"}$$

Actual value at the corner frequency

$$\omega = \omega_c \quad H(\omega) = \frac{50 \cdot j \cdot \omega}{500 \cdot \frac{\text{rad}}{\text{sec}} + j \cdot \omega} = \frac{50 \cdot j}{1 + j \cdot 1} = 25 + 25j \quad |25 + 25j| = 35.355 \quad 20 \cdot \log(35.355) = 30.97 \cdot \text{dB}$$

3 dB lower than the magnitude in the pass band

Magnitude plot

$|H(\omega)|$

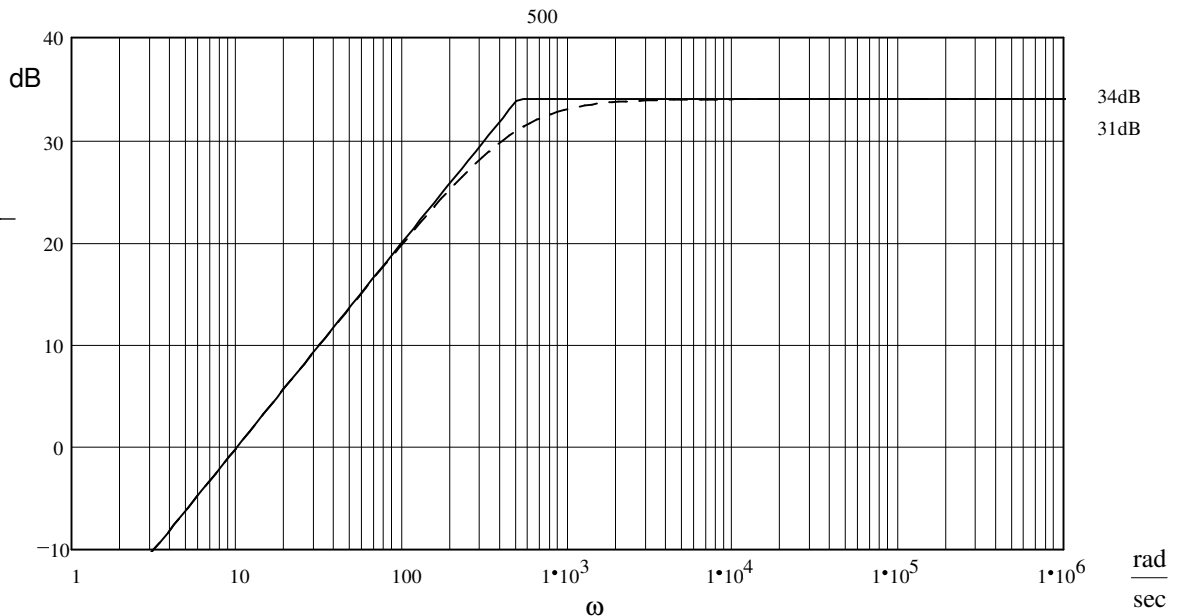

Straight-line approximation _____

Actual - - - - -

ECE 2210 Bode plot Notes p5

Ex. 3 The transfer function may already be worked out:

$$H(f) := 10 \cdot \frac{1 + j \cdot \frac{f}{10 \cdot \text{Hz}}}{1 + j \cdot \frac{f}{500 \cdot \text{Hz}}}$$

Could come from a circuit like this:

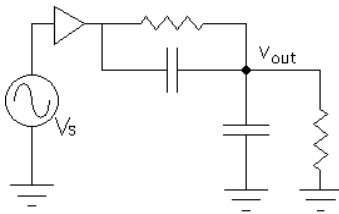

The real and imaginary parts of the numerator are equal at the one corner frequency (called a "zero")

The real and imaginary parts of the denominator are equal at the other corner frequency (pole)

$$1 = j \cdot \frac{f_c}{10 \cdot \text{Hz}} \quad f_{c1} := 10 \cdot \text{Hz}$$

$$1 = j \cdot \frac{f_c}{500 \cdot \text{Hz}} \quad f_{c2} := 500 \cdot \text{Hz}$$

There are now three regions to approximate |H(f)|

Below the first corner frequency: $f < 10 \cdot \text{Hz}$ $|H(f)| \simeq \left| 10 \cdot \frac{1}{1} \right| = 10 \quad 20 \cdot \log(10) = 20 \cdot \text{dB}$

Between the corner frequencies: $10 \cdot \text{Hz} < f < 500 \cdot \text{Hz}$ $|H(f)| \simeq \left| 10 \cdot \frac{j \cdot \frac{f}{10}}{1} \right| = f \quad \text{proportional to } f$

Above the second corner frequency: $1000 \cdot \text{Hz} < f$ $|H(f)| \simeq \left| 10 \cdot \frac{j \cdot \frac{f}{10}}{j \cdot \frac{f}{500}} \right| = 500 \quad 20 \cdot \log(500) = 53.98 \cdot \text{dB}$

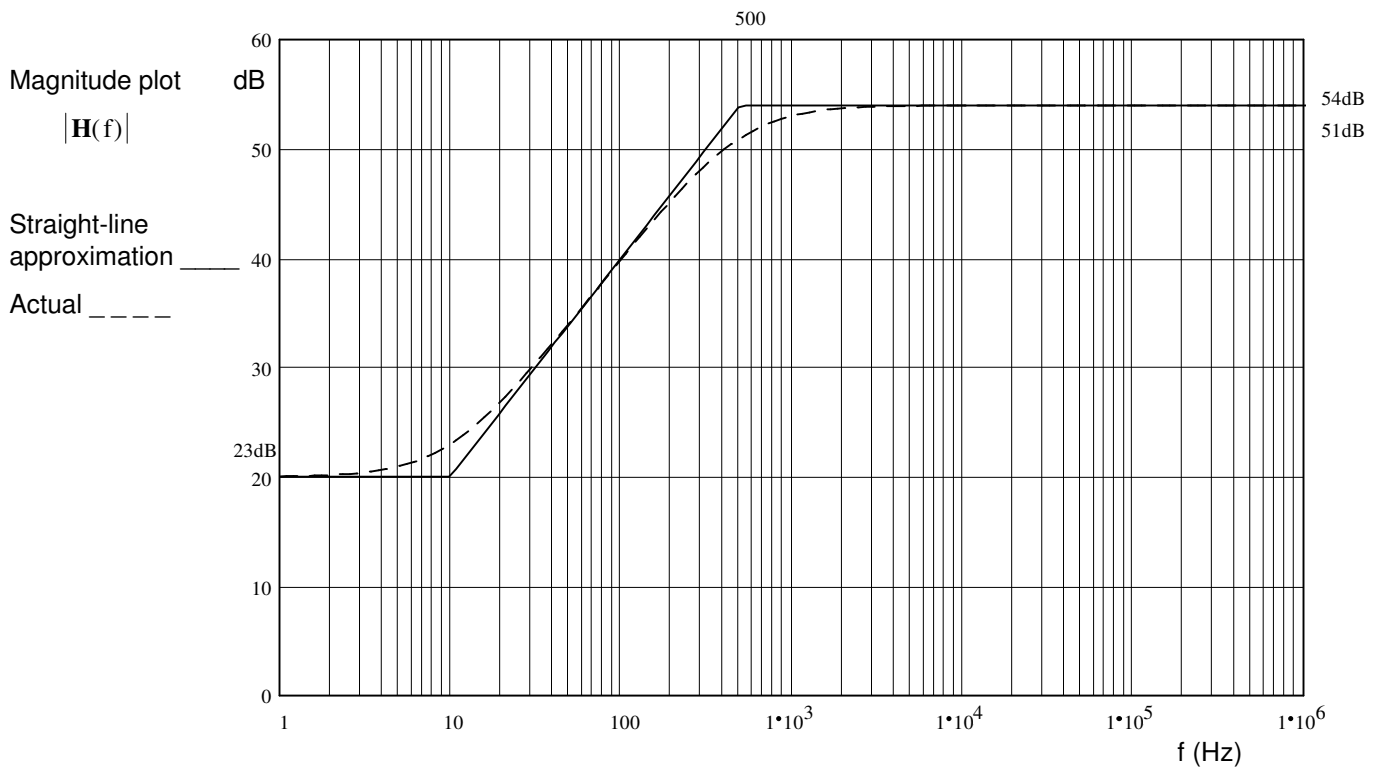

ECE 2210 Bode plot Notes p6

Ex. 4

A Transfer function of a typical amplifier:
$$H(\omega) := \frac{j \cdot \omega \cdot 0.182 \cdot \text{sec}}{\left(1 + \frac{j \cdot \omega}{6.875 \cdot 10^4 \cdot \frac{\text{rad}}{\text{sec}}}\right) \cdot \left(1 + \frac{j \cdot \omega}{416.67 \cdot \frac{\text{rad}}{\text{sec}}}\right)}$$

$$\omega_{C1} := 416.67 \cdot \frac{\text{rad}}{\text{sec}}$$

$$\omega_{C2} := 6.875 \cdot 10^4 \cdot \frac{\text{rad}}{\text{sec}}$$

Between the two poles (passband):
$$H(\omega) \simeq \frac{j \cdot \omega_i \cdot 0.182}{(1) \cdot \left(\frac{j \cdot \omega_i}{416.67}\right)} = 75.834 \quad 20 \cdot \log(75.834) = 37.6$$

Below ω_{C1}
$$H(\omega) \simeq \frac{j \cdot \omega \cdot 0.182}{(1) \cdot (1)} \quad \text{proportional to } \omega$$

Above ω_{C2}
$$H(\omega) \simeq \frac{j \cdot \omega \cdot 0.182}{\left(\frac{j \cdot \omega}{6.875 \cdot 10^4}\right) \cdot \left(\frac{j \cdot \omega}{416.67}\right)} \quad \text{inversely proportional to } \omega$$

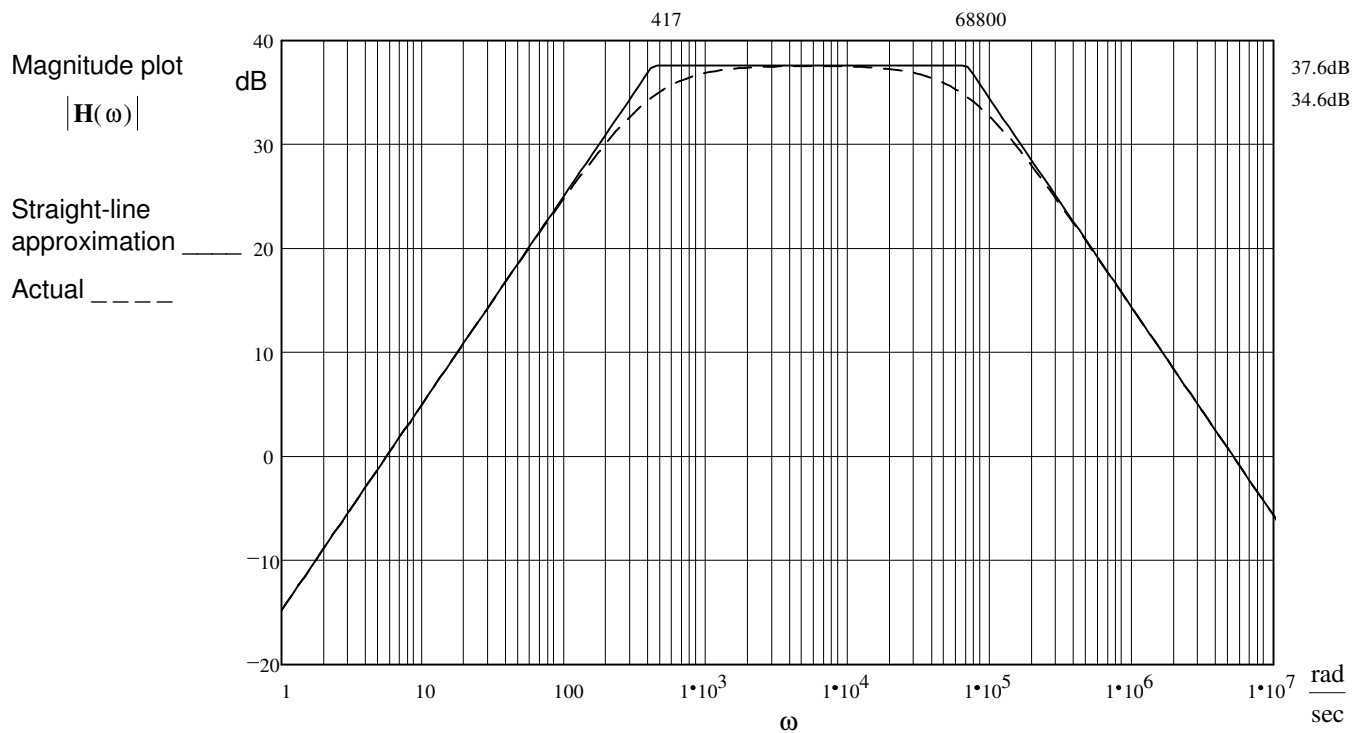

Warning

The Bode plots that we've covered here are the simplest types and only magnitude plots. This will do for an initial introduction to simple filters, but this coverage is *not* complete. Complete Bode plots also include phase plots which we haven't looked at at all. Also, if some poles and zeroes are too close to each other they can interact and even result in complex poles. If asked in a future classes if you have "covered" Bode plots, do not make the mistake of saying "yes".

Folder Number _____ Name _____

ECE 2210 homework # 14

Due: Fri, 3/18/22

c

Read the *Frequency Response, Filters & Bode Plots* handout and/or sections 2.31-33 in your textbook.

1. Convert the following ratios to dB.

Example: ratio = 12 $20 \cdot \log(12) = 21.6 \text{ dB}$

a) $\frac{4}{1}$

b) $\frac{1}{4}$

c) 500

d) 20000

2. Convert 20 dB, 46 dB, -46 dB and 80 dB to voltage ratios.

Example: 50 dB, voltage ratio = $10^{\frac{50}{20}} = 316.23$

a) 20 dB

b) 46 dB

c) -46 dB

d) 80 dB

3. a) Find the transfer function of the filter circuit shown. V_{in} is the input and V_L is the output.

$H(\omega) = ?$

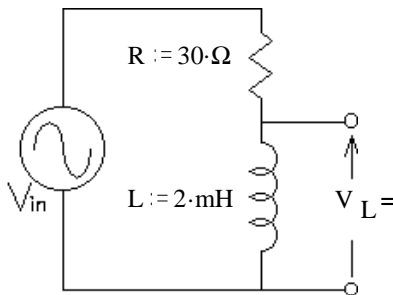

b) Find the corner frequency(ies).

Transcribe the results of parts a) and b) here: $H(\omega)=$

Corner frequency(ies):

c) Find the approximations of the transfer function in each frequency region, find magnitudes in dB, and slopes in dB/decade.

d) Draw the asymptotic Bode plot (the straight-line approximation) of the filter circuit shown above. Accurately draw it on the graph paper provided. Label the vertical axis with numbers in dB.

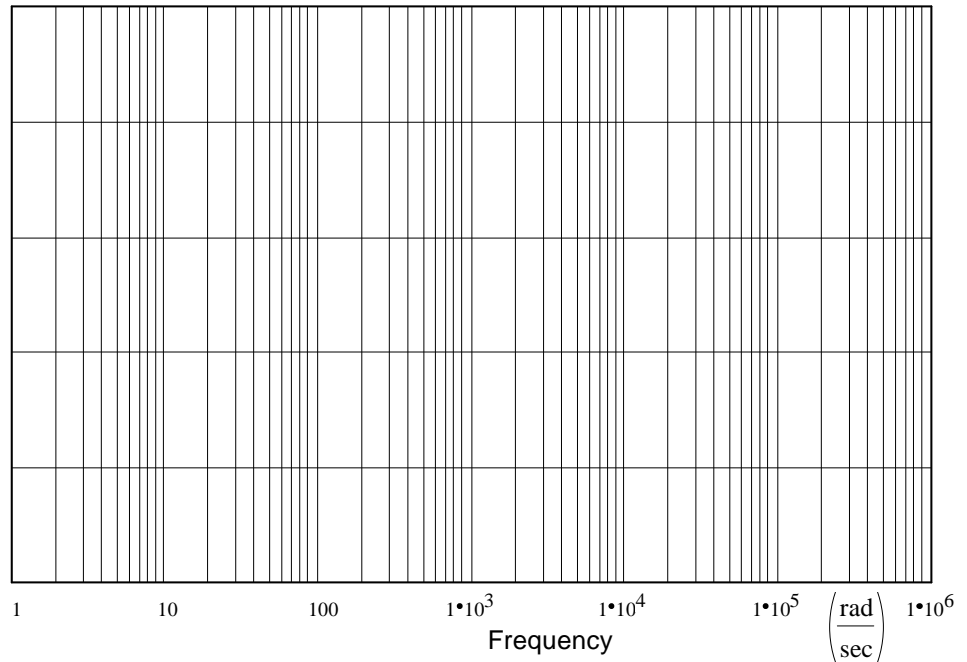

e) The asymptotic Bode plot is not exact. Sketch the actual magnitude of the transfer function on the same plot. For the frequency where this difference is largest (the corner frequency), calculate the actual magnitude.

f) Calculate the actual magnitude of the transfer function at the corner frequency.

g) Calculate the actual magnitude of the transfer function at one octave above the corner frequency ($2\omega_c$).

For **ALL** plotting problems, you must show the steps you use to get the Bode plot like I showed in lecture and the notes. That is, show things like the corner frequency(ies), the approximations of the transfer function in each frequency region, slopes and calculations of dB, numbers on plots, actual magnitude plots, etc..

4. Draw the asymptotic Bode plot (the straight-line approximation) of the following transfer functions.

$$\text{a) } \mathbf{H}_a(\omega) := \frac{20}{1 + j \cdot \frac{\omega}{4000 \cdot \frac{\text{rad}}{\text{sec}}}}$$

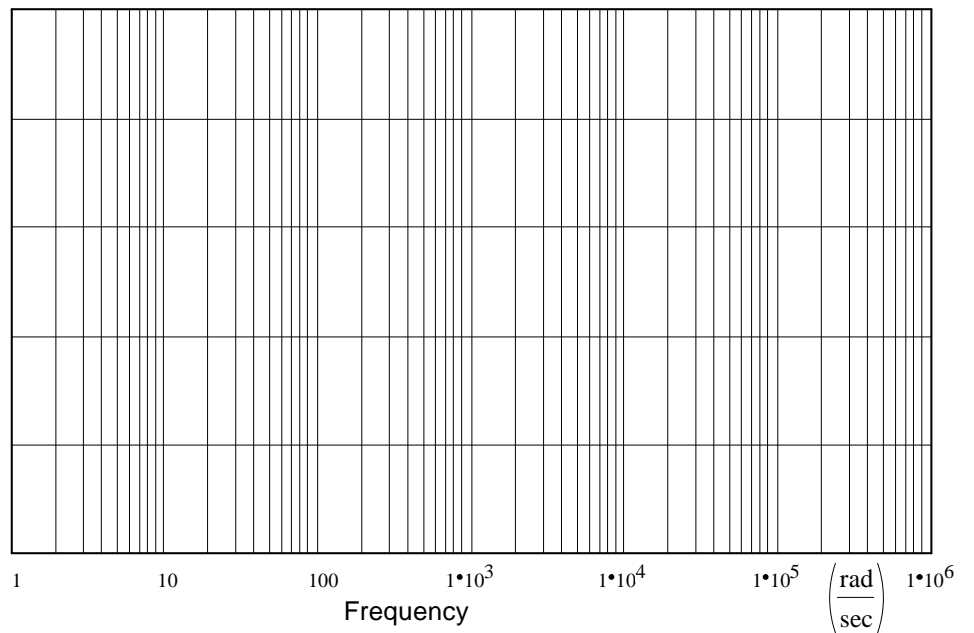

b) $H_b(\omega) := \frac{120 \cdot j \cdot \omega}{400 \cdot \frac{\text{rad}}{\text{sec}} + j \cdot 4 \cdot \omega}$

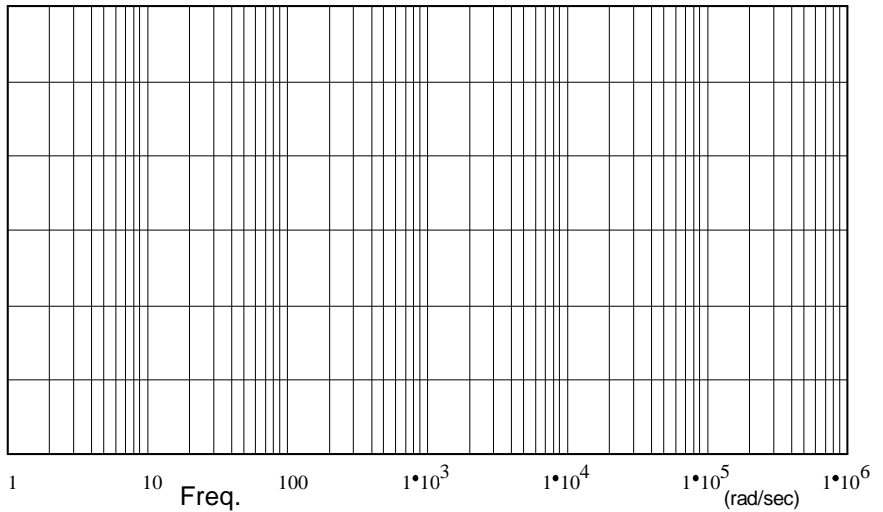

Turn over, more on next page

Answers 1. 12dB, -12dB, 54dB, 86dB 2. 10, 200, 0.005, 10⁴

3. a) $\frac{j \cdot \omega \cdot L}{j \cdot \omega \cdot L + R}$ b) $15000 \cdot \frac{\text{rad}}{\text{sec}}$ d) Magnitude plot $|H(\omega)|$
- c) $\omega < \omega_c$ $H(\omega) \approx \frac{j \cdot \omega \cdot L}{R}$ proportional to ω slope +20 dB/dec
- $\omega > \omega_c$ $H(\omega) \approx \frac{j \cdot \omega \cdot L}{j \cdot \omega \cdot L} = 1$ flat at $20 \cdot \log(1) = 0 \text{ dB}$
- c) -3dB at 15000 rad/sec d) -1dB at 30000 rad/sec

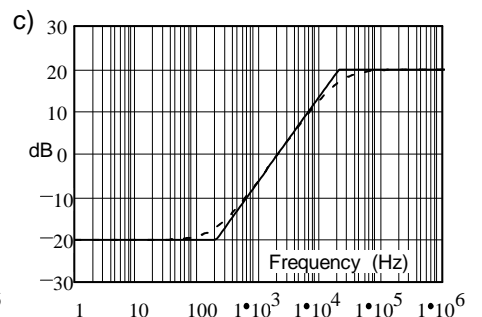
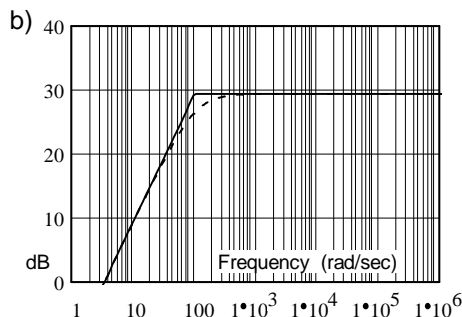
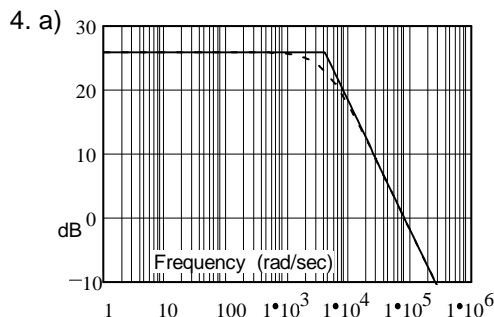
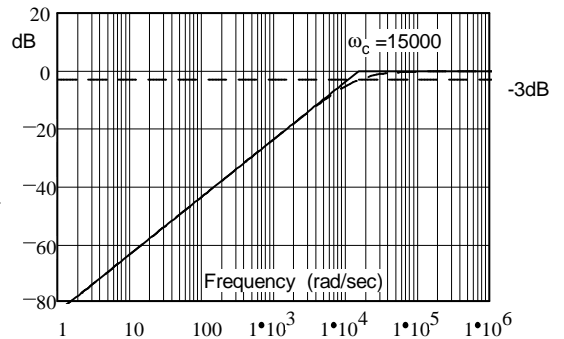

5. 3. high-pass 4.a) low-pass b) high-pass c) high-pass

6. Slope -20dB/dec to 20Hz, flat at 3.5dB to 3kHz, slope +20dB/dec to 40kHz, rest flat at 26dB.

b) Actual magnitudes: 6.5dB at 20Hz, 6.5dB at 3kHz, 23dB/dec at 40kHz. c) zeros: 20Hz, 3kHz, pole: 40kHz

$$c) \mathbf{H}_c(f) := 0.1 \cdot \frac{1 + j \cdot \frac{f}{200 \cdot \text{Hz}}}{1 + j \cdot \frac{f}{20000 \cdot \text{Hz}}}$$

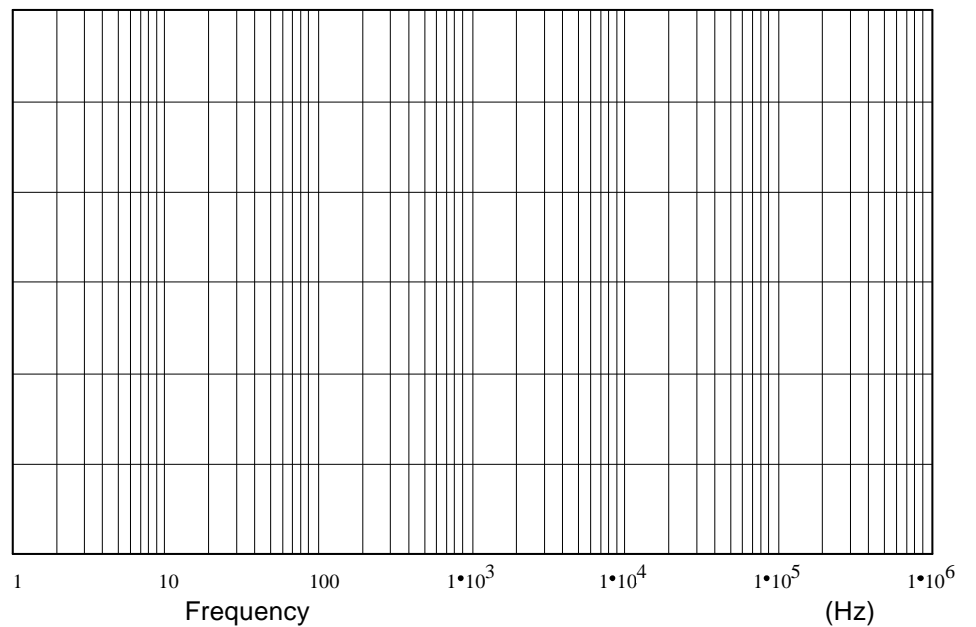

5. Determine the type of each of the filters in problems 3 and 4, low-pass, band-pass, or high-pass.

3.

4.a)

b)

c)

ECE 2210 homework # 14, p6

6. a) Draw the asymptotic Bode plot (the straight-line approximation) of the transfer function shown. Accurately draw it on the graph provided.

$$H(f) = \frac{(3 \cdot \text{kHz} + j \cdot f) \cdot \left(1 \cdot \text{Hz} + \frac{j \cdot f}{20}\right)}{j \cdot f \cdot \left(\frac{j \cdot f}{400} + 100 \cdot \text{Hz}\right)}$$

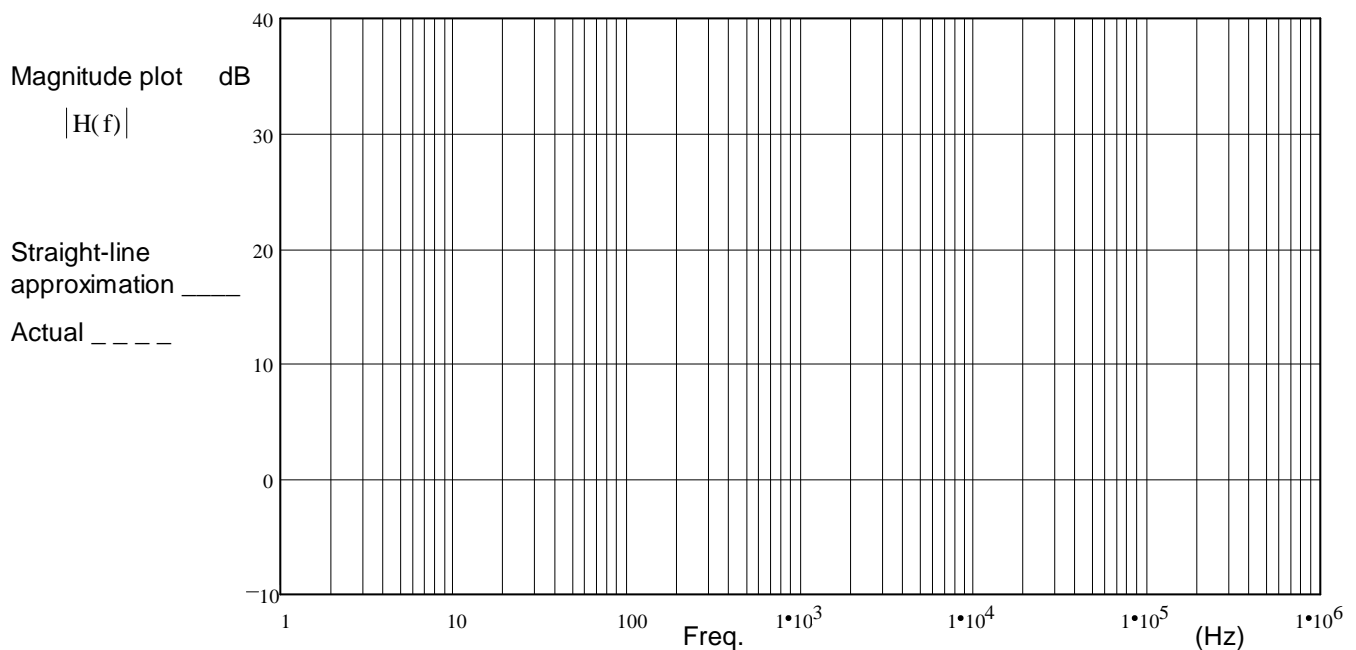

b) The asymptotic Bode plot is not exact. Using a dotted line, sketch the actual magnitude of the transfer function $|H(f)|$ on the plot above. Indicate the point(s) where the difference between the two lines is the biggest (draw arrow(s)) and write down the actual magnitude(s) at that (those) point(s).

c) Identify all zeros and poles of the transfer function.