

RMS

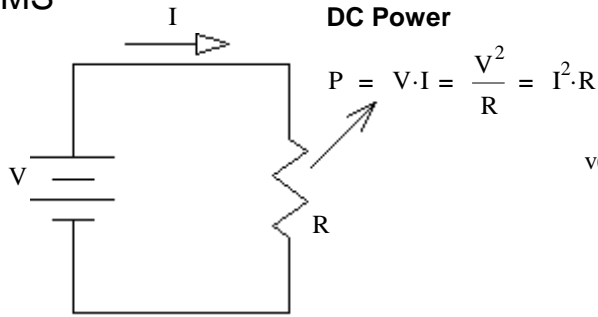

$$v(t) = V_p \cdot \cos(\omega \cdot t)$$

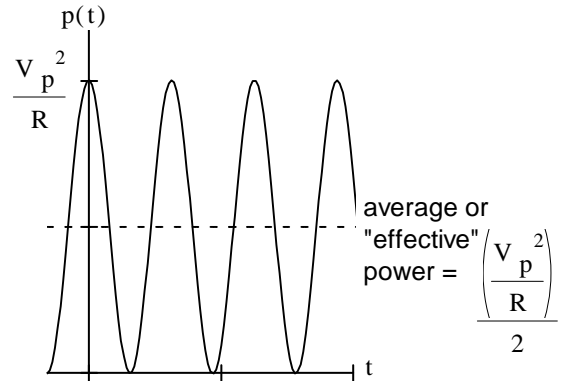
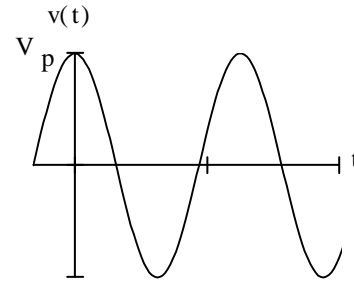
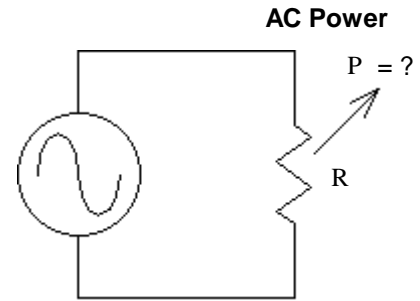

Couldn't we define an "effective" voltage that would allow us to use the same relationships for AC power as used for DC power?

$$P_{ave} = \frac{\left(\frac{V_p^2}{R}\right)}{2} = \frac{\left(\frac{V_p^2}{2}\right)}{R} = \frac{\left(\frac{V_p}{\sqrt{2}}\right)^2}{R}$$

$$V_{eff} = \sqrt{\left(\frac{V_p}{\sqrt{2}}\right)^2} = \frac{V_p}{\sqrt{2}} = V_{rms} = \sqrt{\frac{1}{T} \int_0^T (v(t))^2 dt}$$

Root
Square
Mean (average)

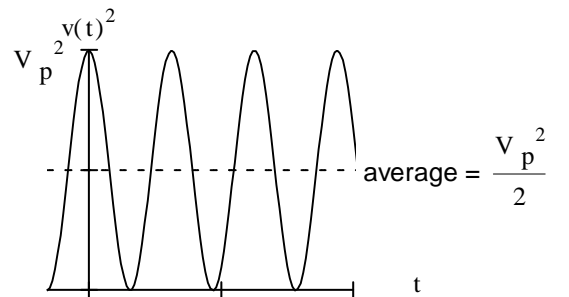

RMS Root of the **M**ean of the **S**quare
Use RMS in power calculations

Sinusoids

$$\begin{aligned}
 V_{rms} &= \sqrt{\frac{1}{T} \int_0^T (v(t))^2 dt} = \sqrt{\frac{1}{T} \int_0^T (V_p \cdot \cos(\omega \cdot t))^2 dt} = \sqrt{\frac{1}{T} \int_0^T V_p^2 \cdot \left(\frac{1}{2} + \frac{1}{2} \cos(2 \cdot \omega \cdot t)\right) dt} \\
 &= \frac{V_p}{\sqrt{2}} \cdot \sqrt{\frac{1}{T} \int_0^T (1) dt + \frac{1}{T} \int_0^T \cos(2 \cdot \omega \cdot t) dt} = \frac{V_p}{\sqrt{2}} \cdot \sqrt{1 + 0}
 \end{aligned}$$

Common household power

$f = 60\text{-Hz}$
 $\omega = 377 \cdot \frac{\text{rad}}{\text{sec}}$
 $T = 16.67\text{-ms}$

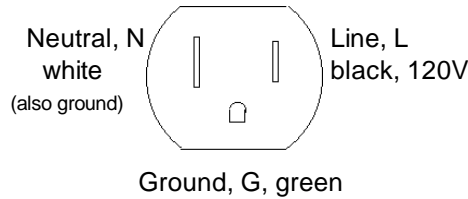

$V_{\text{rms}} := 120\text{-V}$
 $V_p = V_{\text{rms}} \cdot \sqrt{2} = 170\text{-V}$

What about other wave shapes??

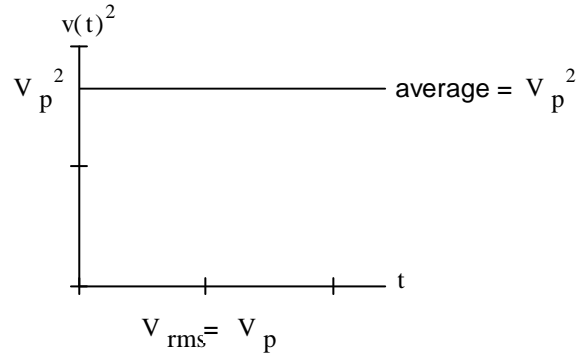
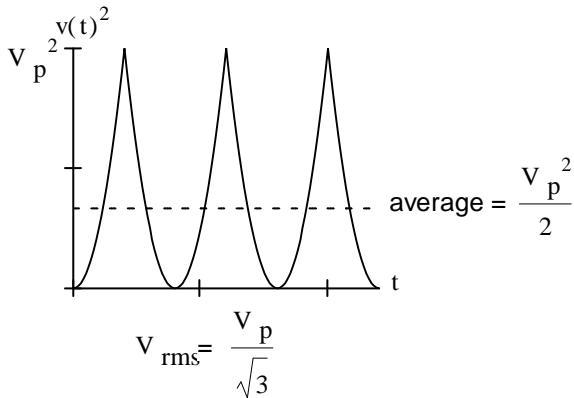
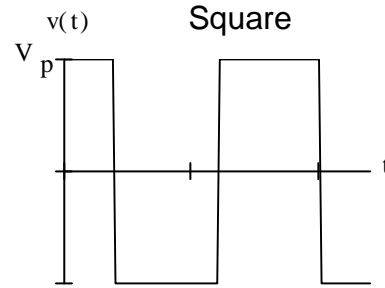
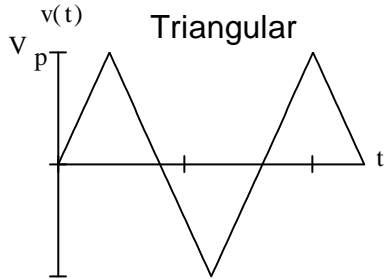

Works for all types of triangular and sawtooth waveforms

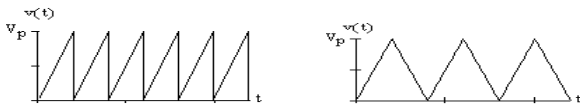

Same for DC

How about AC + DC ?

$$\begin{aligned}
 V_{\text{rms}} &= \sqrt{\frac{1}{T} \int_0^T (v(t))^2 dt} \\
 &= \sqrt{\frac{1}{T} \int_0^T (V_p \cdot \cos(\omega t) + V_{\text{DC}})^2 dt} \\
 &= \sqrt{\frac{1}{T} \int_0^T \left[(V_p \cdot \cos(\omega t))^2 + 2 \cdot (V_p \cdot \cos(\omega t)) \cdot V_{\text{DC}} + V_{\text{DC}}^2 \right] dt} \\
 &= \sqrt{\frac{1}{T} \int_0^T (V_p \cdot \cos(\omega t))^2 dt + \frac{1}{T} \int_0^T 2 \cdot (V_p \cdot \cos(\omega t)) \cdot V_{\text{DC}} dt + \frac{1}{T} \int_0^T V_{\text{DC}}^2 dt} \\
 &\quad \text{--- zero over one period ---} \\
 &= \sqrt{V_{\text{rmsAC}}^2 + 0 + V_{\text{DC}}^2} = \sqrt{V_{\text{rmsAC}}^2 + V_{\text{DC}}^2}
 \end{aligned}$$

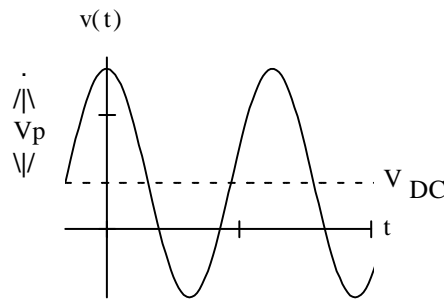

ECE 2210 Lecture 20 notes p3

sinusoid: $V_{rms} = \frac{V_p}{\sqrt{2}}$ $I_{rms} = \frac{I_p}{\sqrt{2}}$

triangular: $V_{rms} = \frac{V_p}{\sqrt{3}}$ $I_{rms} = \frac{I_p}{\sqrt{3}}$

square: $V_{rms} = V_p$ $I_{rms} = I_p$

waveform + DC $V_{rms} = \sqrt{V_{rmsAC}^2 + V_{DC}^2}$

rectified average $V_{ra} = \frac{1}{T} \int_0^T |v(t)| dt$

$V_{ra} = \frac{2}{\pi} \cdot V_p$ $I_{ra} = \frac{2}{\pi} \cdot I_p$

$V_{ra} = \frac{1}{2} \cdot V_p$ $I_{ra} = \frac{1}{2} \cdot I_p$

$V_{ra} = V_{rms} = V_p$ $I_{ra} = I_{rms} = I_p$

Most AC meters don't measure true RMS. Instead, they measure V_{ra} , display $1.11V_{ra}$, and call it RMS. That works for sine waves but not for any other waveform.

Some waveforms don't fall into these forms, then you have to perform the math from scratch

For waveform shown

The average DC (V_{DC}) value

$$\frac{2 \cdot V \cdot (4 \cdot \text{ms}) + (-5 \cdot V) \cdot (2 \cdot \text{ms})}{6 \cdot \text{ms}} = -0.333 \cdot V$$

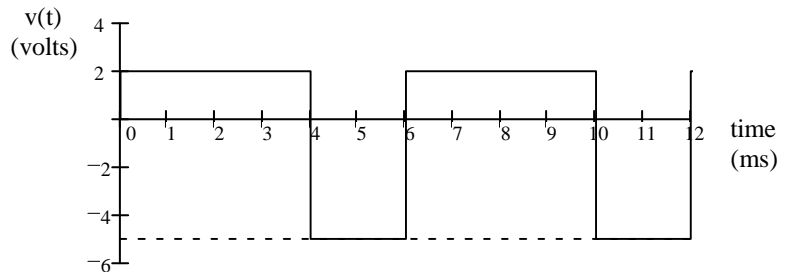

The RMS (effective) value

Graphical way

$$\frac{4 \cdot V^2 \cdot (4 \cdot \text{ms}) + 25 \cdot V^2 \cdot (2 \cdot \text{ms})}{6 \cdot \text{ms}} = 11 \cdot V^2$$

$$V_{RMS} := \sqrt{11 \cdot V^2} \quad V_{RMS} = 3.32 \cdot V$$

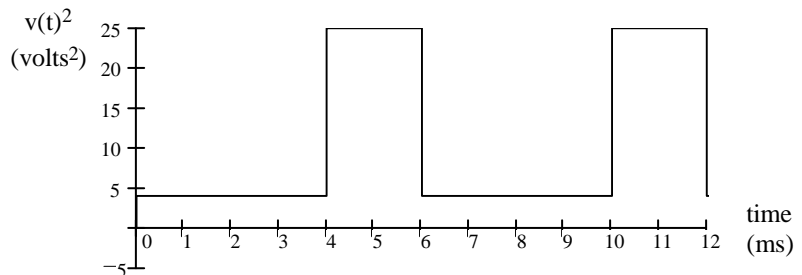

OR...

$$V_{RMS} = \sqrt{\frac{1}{T} \int_0^T (v(t))^2 dt}$$

$$= \sqrt{\frac{1}{6 \cdot \text{ms}} \left[\int_{0 \cdot \text{ms}}^{4 \cdot \text{ms}} (2 \cdot V)^2 dt + \int_{2 \cdot \text{ms}}^{6 \cdot \text{ms}} (-5 \cdot V)^2 dt \right]} = \sqrt{\frac{1}{6 \cdot \text{ms}} \cdot [4 \cdot \text{ms} \cdot (2 \cdot V)^2 + 2 \cdot \text{ms} \cdot (-5 \cdot V)^2]} = 3.32 \cdot V$$

The voltage is hooked to a resistor, as shown, for 6 seconds.

The energy is transferred to the resistor during that 6 seconds:

$$P_L := \frac{V_{RMS}^2}{R_L} \quad P_L = 0.22 \cdot W$$

$$W_L := P_L \cdot 6 \cdot \text{sec} \quad W_L = 1.32 \cdot \text{joule} \quad \text{All converted to heat}$$

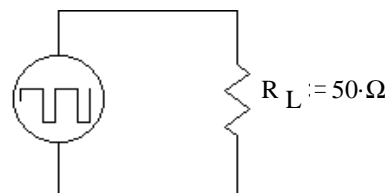

Use RMS in power calculations

$$P = I_{Rms}^2 \cdot R = \frac{V_{Rms}^2}{R} \quad \text{for Resistors ONLY !!}$$

Capacitors and Inductors

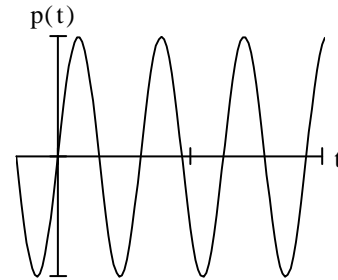
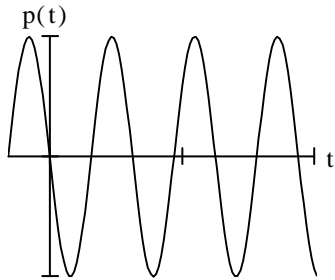
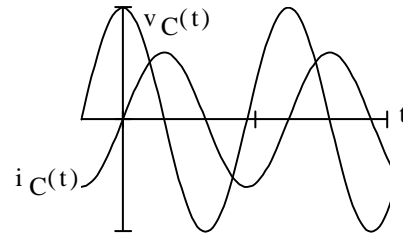
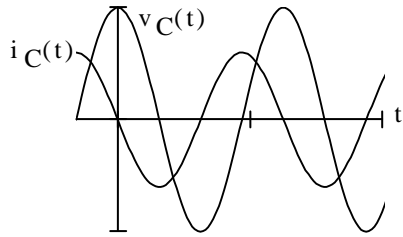
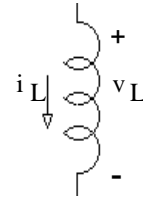
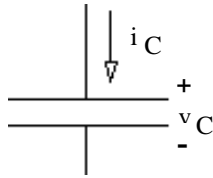

Average power is ZERO $P = 0$

Average power is ZERO $P = 0$

Capacitors and Inductors DO NOT dissipate (real) average power.

If current and voltage are not in phase, only the in-phase part of the current matters for the power-- DOT PRODUCT

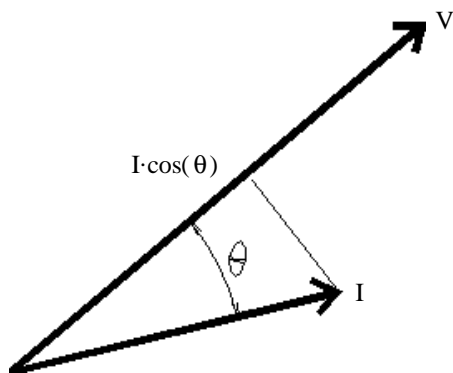

"Lagging" power
Inductor dominates

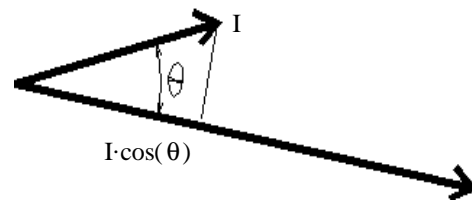

"Leading" Power
Capacitor dominates

Real Power

$$P = I_{R_{rms}}^2 \cdot R = \frac{V_{R_{rms}}^2}{R} \text{ for resistors } \text{---}\text{---}\text{---}$$

other wise....

$$P = V_{rms} \cdot I_{rms} \cdot \cos(\theta) = I_{rms}^2 \cdot |Z| \cdot \cos(\theta) = \frac{V_{rms}^2}{|Z|} \cdot \cos(\theta) \quad \text{units: watts, kW, MW, etc.}$$

$$P = \text{"Real" Power (average)} = V_{rms} \cdot I_{rms} \cdot pf = I_{rms}^2 \cdot |Z| \cdot pf = \frac{V_{rms}^2}{|Z|} \cdot pf$$

Reactive Power

 capacitors -> - Q

$$Q_C = I_{C_{rms}}^2 \cdot X_C = \frac{V_{C_{rms}}^2}{X_C} \quad X_C = -\frac{1}{\omega \cdot C} \text{ and is a negative number}$$

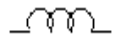
 inductors -> + Q

$$Q_L = I_{L_{rms}}^2 \cdot X_L = \frac{V_{L_{rms}}^2}{X_L} \quad X_L = \omega \cdot L \text{ and is a positive number}$$

other wise....

$$Q = \text{Reactive "power"} = V_{rms} \cdot I_{rms} \cdot \sin(\theta) \quad \text{units: VAR, kVAR, etc. "volt-amp-reactive"}$$

Complex and Apparent Power

$$S = \text{Complex "power"} = V_{rms} \cdot \overline{I_{rms}} = P + jQ = V_{rms} I_{rms} / \theta \quad \text{units: VA, kVA, etc. "volt-amp"}$$

/ complex conjugate

NOT $I_{rms}^2 \cdot Z$ **NOR** $\frac{V_{rms}^2}{Z}$

$$S = \text{Apparent "power"} = |S| = V_{rms} \cdot I_{rms} = \sqrt{P^2 + Q^2} \quad \text{units: VA, kVA, etc. "volt-amp"}$$

Power factor

$$pf = \cos(\theta) = \text{power factor (sometimes expressed in \%)} \quad 0 \leq pf \leq 1$$

θ is the **phase angle** between the voltage and the current or the phase angle of the impedance. $\theta = \theta_Z$

$\theta < 0$ Load is "Capacitive", power factor is "leading". This condition is very rare

$\theta > 0$ Load is "Inductive", power factor is "lagging". This condition is so common you can assume any power factor given is lagging unless specified otherwise. Transformers and motors make most loads inductive.

Industrial users are charged for the reactive power that they use, so power factor < 1 is a bad thing.

Power factor < 1 is also bad for the power company. To deliver the same power to the load, they have more line current (and thus more line losses).

Power factors are "corrected" by adding capacitors (or capacitive loads) in parallel with the inductive loads which cause the problems. (In the rare case that the load is capacitive, the pf would be corrected by an inductor.)

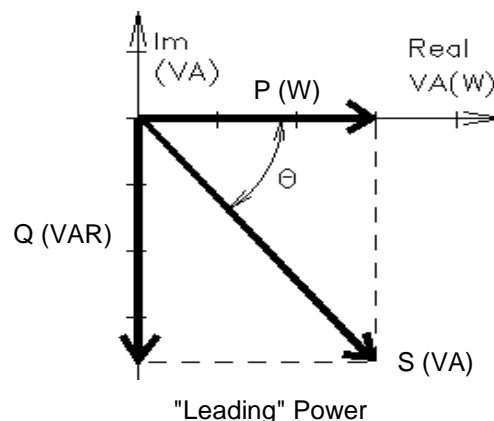
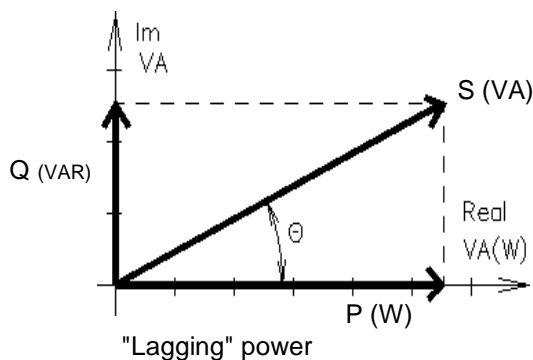

A Transformer is two coils of wire that are magnetically coupled.

Transformers are only useful for AC, which is one of the big reasons electrical power is generated and distributed as AC.

Transformer turns and turns ratios are rarely given, V_p/V_s is much more common where V_p/V_s is the rated primary over rated secondary voltages. You may take this to be the same as N_1/N_2 although in reality N_2 is usually a little bit bigger to make up for losses. Also common: $V_p : V_s$.

Both RMS

Transformers are rated in VA Transformer Rating (VA) = (rated V) x (rated I) , on either side.

Don't allow voltages over the rated V , regardless of the actual current.

Don't allow currents over the rated I , regardless of the actual voltage.

Ideal Transformers

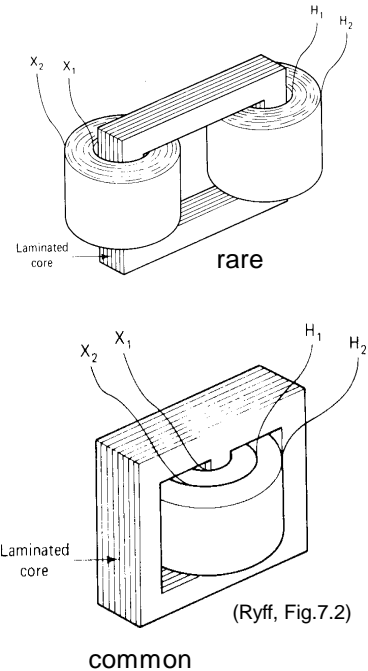
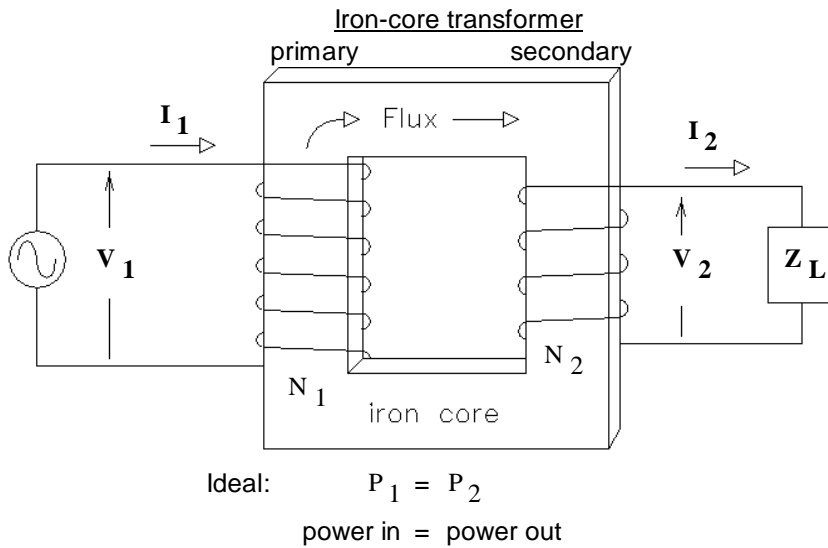

Transformation of voltage and current

$$\frac{N_1}{N_2} = \frac{V_1}{V_2} = \frac{I_2}{I_1}$$

Turns ratio

Turns ratio as defined in Chapman text: $a = \frac{N_1}{N_2}$, same as $N = \frac{N_1}{N_2}$

Note: some other texts define the turns ratio as: $\frac{N_2}{N_1}$

Be careful how you and others use this term

Transformation of impedance

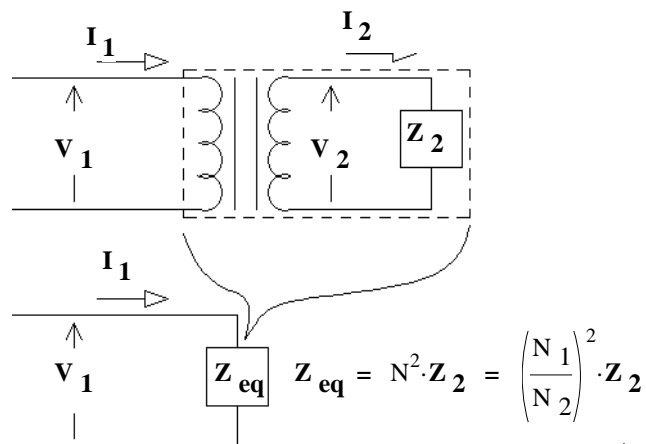

You can replace the entire transformer and load with (Z_{eq}). This "impedance transformation" can be very handy.

Transformers can be used for "impedance matching"

This also works the opposite way, to move an impedance from the primary to the secondary, multiply by: $\left(\frac{N_2}{N_1}\right)^2$

Other Transformers

- Multi-tap transformers: Many transformers have more than two connections to primary and/or the secondary. The extra connections are called "taps" and may allow you to select from several different voltages or get more than one voltage at the same time.
- Isolation Transformers: Almost all transformers isolate the primary from the secondary. An Isolation transformer has a 1:1 turns ratio and is just for isolation.
- Auto Transformers: Auto transformers have only one winding with taps for various voltages. The primary and secondary are simply parts of the same winding. These parts may overlap. Any regular transformer can be wired as an auto transformer. Auto transformers DO NOT provide isolation.
- Vari-AC: A special form of auto transformer with an adjustable tap for an adjustable output voltage.
- LVDT: A Linear-Variable-Differential-Transformers has moveable core which couples the primary winding to the secondary winding(s) in such a way the the secondary voltage is proportional to the position of the core. LVDTs are used as position sensors.

Home power

Standard 120 V outlet connections are shown at right.

The 3 lines coming into your house are **NOT** 3-phase. They are +120 V, Gnd, -120 V

(The two 120s are 180° out-of-phase, allowing for 240 V connections)

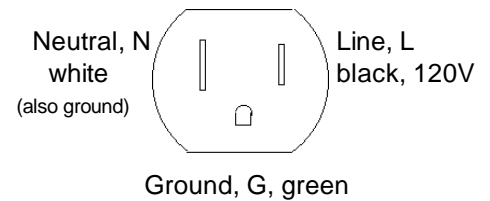

3-Phase Power (FYI ONLY)

Single phase power pulses at 120 Hz. This is not good for motors or generators over 5 hp.

Three phase power is constant as long as the three loads are balanced.

Three lines are needed to transmit 3-phase power. If loads are balanced, ground return current will be zero.

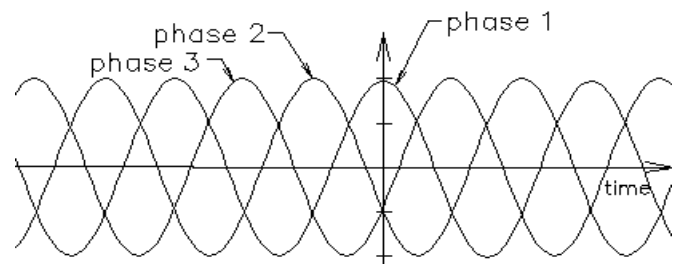

Wye connection:

Connect each load or generator phase between a line and ground.

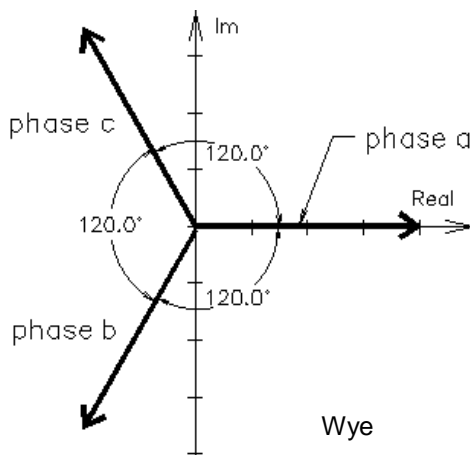

$$V_{LN} = \frac{V_{LL}}{\sqrt{3}}$$

$$I_L = \sqrt{3} \cdot I_{LL}$$

Delta connection:

Connect each load or generator phase between two lines.

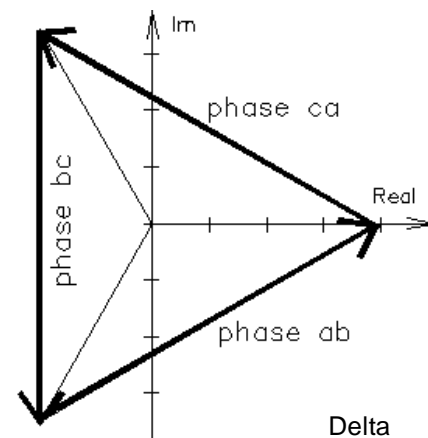

$$V_{LL} = \sqrt{3} \cdot V_{LN}$$

$$I_{LL} = \frac{I_L}{\sqrt{3}}$$

3-Phase Power (FYI ONLY)

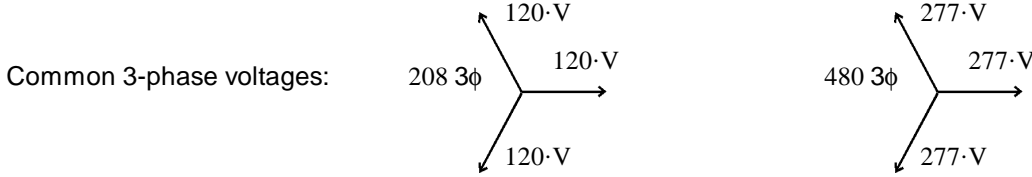

Apparent Power: $|S_{3\phi}| = 3 \cdot V_{LN} \cdot I_L = 3 \cdot V_{LL} \cdot I_{LL} = \sqrt{3} \cdot V_{LL} \cdot I_L$

Power: $P_{3\phi} = 3 \cdot V_{LN} \cdot I_L \cdot \text{pf} = 3 \cdot V_{LL} \cdot I_{LL} \cdot \text{pf} = \sqrt{3} \cdot V_{LL} \cdot I_L \cdot \text{pf} = S_{3\phi} \cdot \text{pf} \quad \text{pf} = \cos(\theta)$

Reactive power: $Q_{3\phi} = 3 \cdot V_{LN} \cdot I_L \cdot \sin(\theta) \text{ etc...} = \sqrt{(|S_{3\phi}|)^2 - P_{3\phi}^2}$

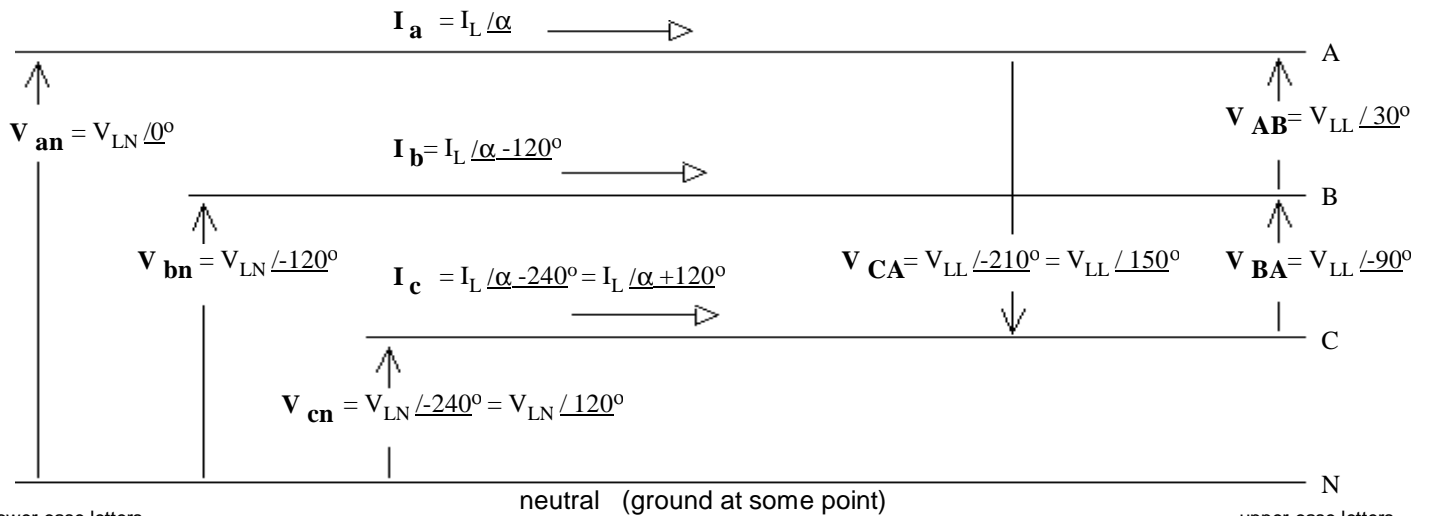

lower-case letters at source end

upper-case letters at load end

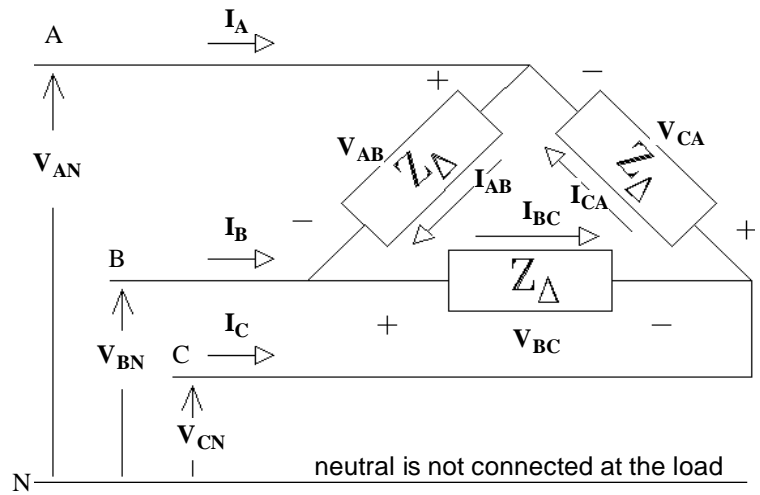
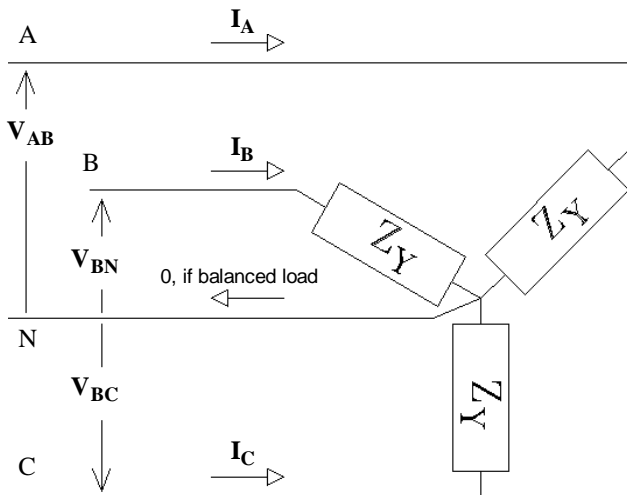

$$|V_{AN}| = |V_{BN}| = |V_{CN}| = V_{LN} = \frac{V_{LL}}{\sqrt{3}}$$

$$|V_{AB}| = |V_{BC}| = |V_{CA}| = V_{LL} = \sqrt{3} \cdot V_{LN}$$

$$|I_A| = |I_B| = |I_C| = I_L = \sqrt{3} \cdot I_{LL}$$

$$|I_{AB}| = |I_{BC}| = |I_{CA}| = I_{LL} = \frac{I_L}{\sqrt{3}}$$

To get equivalent line currents with equivalent voltages

$$Z_Y = \frac{Z_{\Delta}}{3}$$

$$Z_{\Delta} = 3 \cdot Z_Y$$